



IR Outdoor Bullet Camera

User Manual

Note: The manual is subject to change without notice

Part Number: 00125525921_190116

CONTENTS

Chapter 1: Product Introduction

Overview	1
Camera	1
Cable	1
Hardware Installation	2

Chapter 2: Camera Configuration

Accessing the Camera's Configuration Menu (Graphical User Interface) ..	4
Installing CAM-FINDER Software	4
CAM-FINDER	7
Introduction to the CAM-FINDER User Interface	8
Button Functions	8
Web Browser	9
Motorized Lens	10
Configuring the Camera's Setting	11
Browsing Through the Configuration Menu	12
Video - Video Configuration	13
Primary Stream 1	13
Secondary Stream	14
Third Stream	15
Image - Exposure	16
Configurations	16
Day Night Setting	18
Image - Basic Settings	19
Orientation	19
Digital Processing	19
Image - ROI	21

Configurations	21
Image - Privacy Zone	22
Configurations	22
Image - OSD	23
General Settings	23
Text Overlay	23
Network - Basic	24
IPv4 Settings	24
System Settings	24
IPv6 Settings	24
RTMP Settings	25
Network - FTP	26
Configurations	26
Network - SSL	27
SSL Configurations	27
Certificate	27
Network - SSH	28
SSH Configurations	28
Network - 802.1x	29
802.1x Configurations	29
Network - SNMP	30
SNMP Configurations	30
Network - Firewall	31
Firewall Configurations	31
Network - LDAP	32
LDAP Configurations	32
Network - DDNS	33
DDNS Configurations	33

Content

Network - RTSP.....	34	Object Schedule Settings.....	50
RTSP Configurations.....	34	Event - FTP Upload.....	51
Multicast (Stream 1 to Stream 3).....	35	FTP Upload Handler Configurations.....	51
Network - GB28181.....	37	Remote Server.....	51
GB28181 Configurations.....	37	Event - SMTP Notification.....	52
System - Date/Time.....	38	SMTP Notification Handler Configurations.....	52
Date/Time Configurations.....	38	Trigger Event.....	52
Time Setting.....	38	SMTP Server.....	53
Time Zone Setting.....	38	Recipient List.....	53
System - Maintenance.....	39	Event - Network Storage.....	54
System Information.....	39	Network Storage Configurations.....	54
Firmware Update.....	39	Trigger Event.....	54
Backup.....	40	Recipient Setup.....	54
Restore.....	40	Login Certificate.....	55
Video System.....	40	Mount and Remove Network Storage.....	55
System - User Management.....	41	Event - Relay Handler.....	56
Admin Setting.....	41	Relay Handler Configurations.....	56
User List.....	41	Event - SD Record Handler.....	57
User Information.....	42	SD Record Handler Configurations.....	57
Event - Alarm Handler.....	43	SD Information.....	57
Alarm Handler Configurations.....	43	Alarm/Motion/Tampering/Object Detection Settings.....	58
Alarm Schedule Settings.....	43	Record Type Selected: Snapshot.....	58
Event - Motion Detection.....	44	Alarm/Motion/Tampering/Object Detection Settings.....	59
Motion Configurations.....	44	Record Type Selected: Video.....	59
Zone1 to Zone5 Setup.....	44		
Motion Schedule Settings.....	45		
Event - Tampering Alarm.....	46		
Tampering Alarm Configurations.....	46		
Tampering Schedule Settings.....	46		
Event - Object Detection.....	47		
Object Detection Configurations.....	47		
Setup Detection Area.....	49		

CHAPTER 1: PRODUCT INTRODUCTION

Overview

Camera



Cable

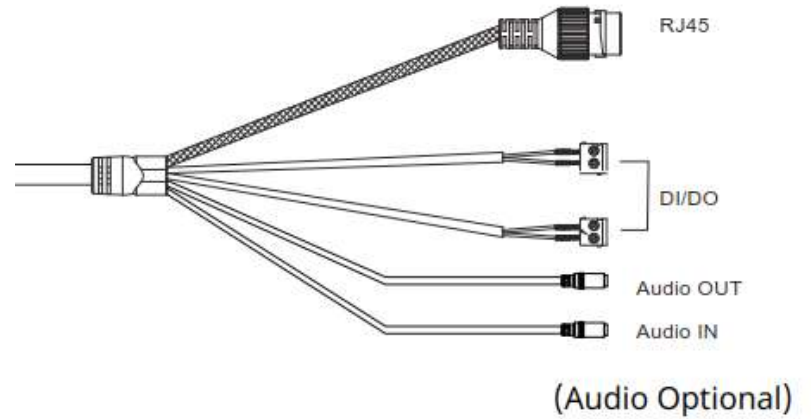

Hardware Installation

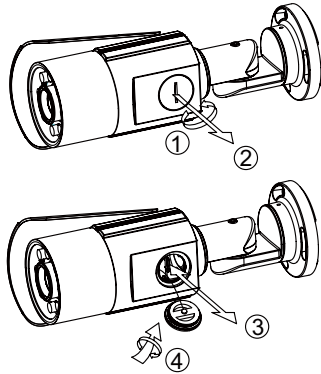

No.	Name
1	Mounting Screws
2	Wall Mount Bracket (ACB-02) W1 Kit
3	Expansion Bolts
4	Mounting Screws
5	Wall or Ceiling Surface
6	Installation Sticker

Description: The mounting surface for the bracket installation needs to withstand at least three times the total weight of the bracket and IP camera.

1. Use the 4 flat head screws to fix the metal adapter plate to the wall mount bracket.
2. Put the installation sticker on the surface (wall or ceiling) of where it will be installed.
3. Take out the screws on the bracket and put them into the expansion bolts to fix the bracket on the surface (wall or ceiling).
4. Remove the base of the camera. Use screws to fix the base onto the bracket.
5. Fix the camera back to the base secured on the bracket.

6. Adjust the direction of the camera to the desired field of view.

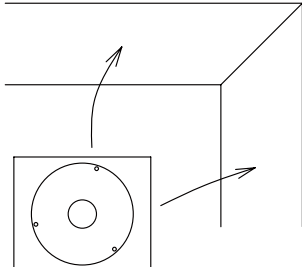

7. Put desiccant and stick it on the internal black plastic base.

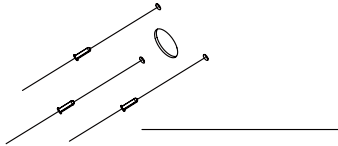

8. Put the cover back and use a hex key wrench to secure the 3 screws. Make sure all the parts of the camera are installed securely.

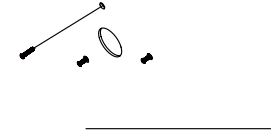

CHAPTER 2: CAMERA CONFIGURATION

Accessing the Camera's Configuration Menu (Graphical User Interface)

The camera's default IP address is 192.168.0.250, make sure the IP address of the computer accessing the camera is on the same network subnet before proceeding.

You can access the camera via a **web browser** or **CAM-FINDER** software. The following information outlines the instructions for each method.

Installing CAM-FINDER Software



Note: If **CAM-FINDER** is already installed, you can skip this section and continue to the next section **CAM-FINDER** on page 7.

1. Download the **CAM-FINDER** installer file. Please access: <http://www.diviotec.com/index.php?tid=1603&pid=31&cid=50>
2. Unzip the **CAM-FINDER** file to a location on the hard drive.
3. Once unzipped, double click on the setup file to start the installation program.
4. Click the **Next** button on the welcome screen to continue.

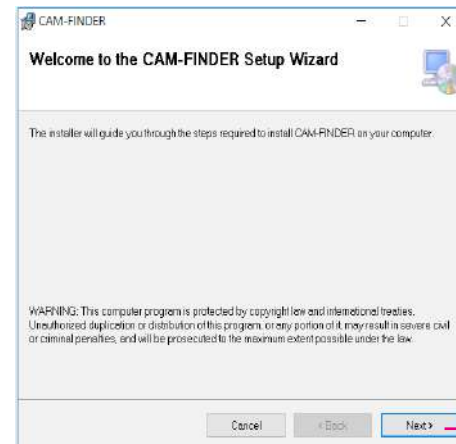

Next button

5. Confirm the directory that the program will be installed on. To specify a different folder, please click on the **Browse** button and locate the desired installation folder.

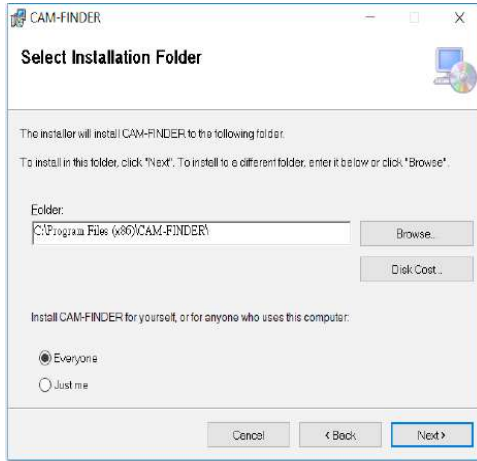

6. To check the available drives you can install the software to and their available and required disk space, please click on the **Disk Cost** button.

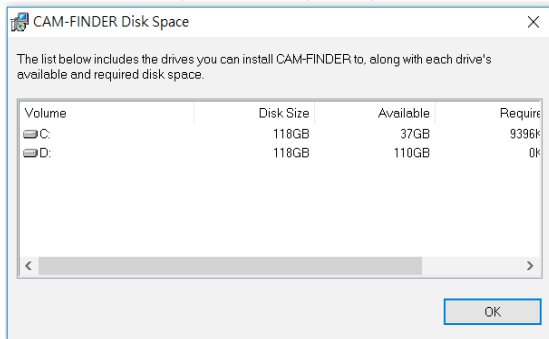

7. Specify which user accounts on the computer can access the program, the options are **Everyone** and **Just me**.

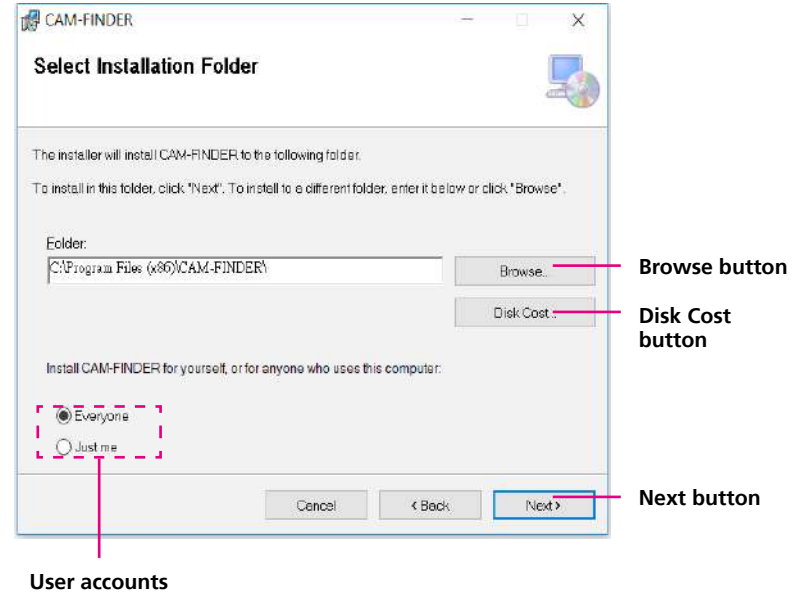

8. Click on the **Next** button to continue.

9. Click on the **Next** button to begin installation.

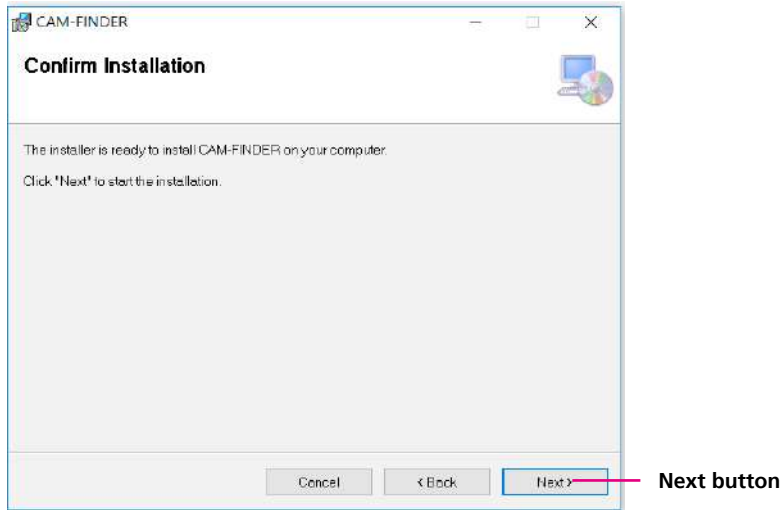

10. Once the installation process is complete, click on the **Close** button to finish. A shortcut will be created on the desktop.

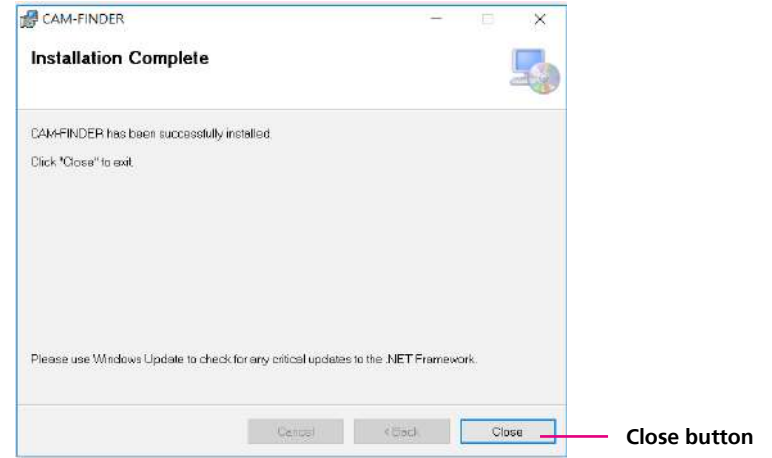

CAM-FINDER

1. Locate and open the **CAM-FINDER** software shortcut on the desktop.



2. When the program is launched, it will begin searching the network for IP cameras automatically (the search will last for up to 90 seconds). You can also manually search cameras by clicking on the **Search** button.

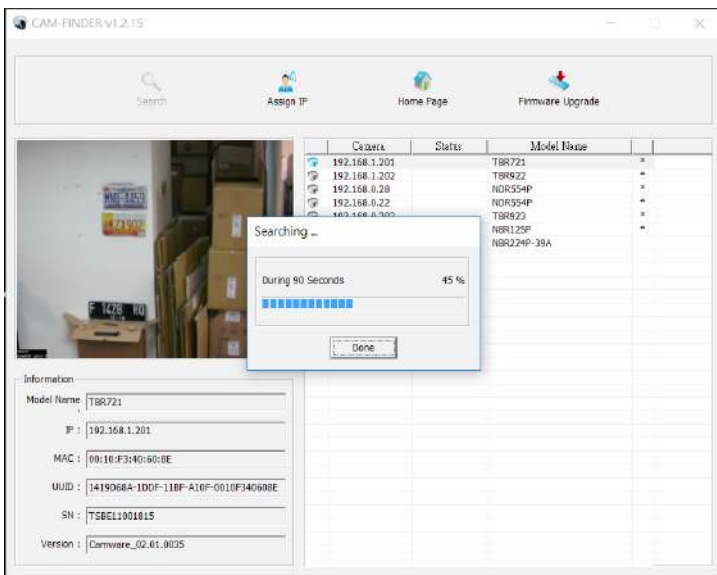

3. Once the camera is discovered, it will show the following information:
 - Model Name
 - IP address
 - MAC address
 - UUID
 - Serial Number
 - Version
4. You can access the menu by double clicking the camera's **IP address** under **Camera List**. The IE will be opened automatically.

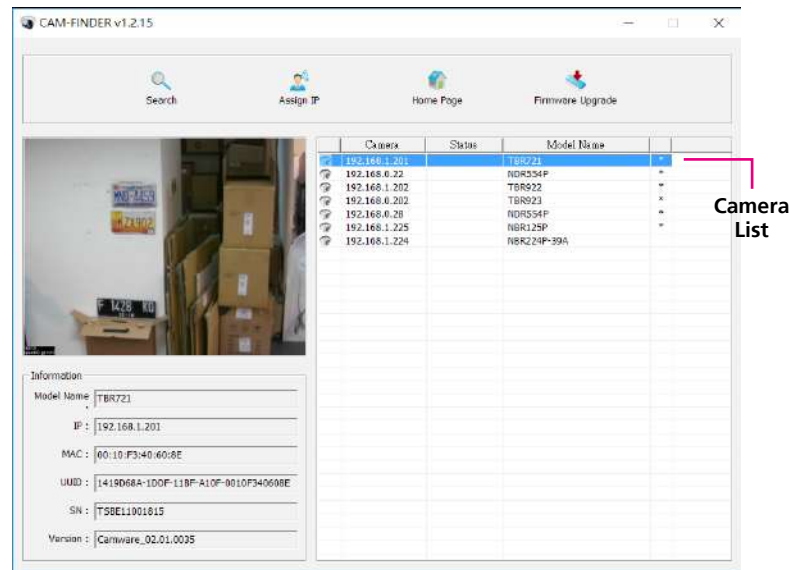

Introduction to the CAM-FINDER User Interface

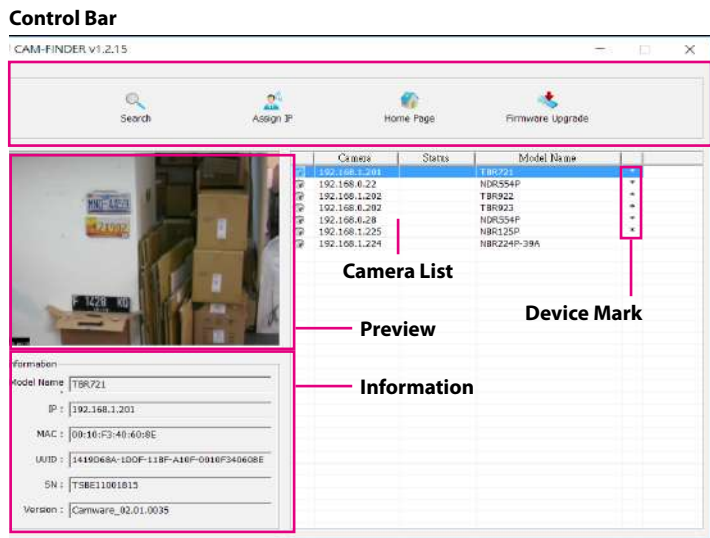

UI Block	Description
Control Bar	Contains [Search] , [Assign IP] , [Home Page] and [Firmware Upgrade] buttons.
Preview	Displays the selected camera image.
Information	Displays the selected camera information such as Model Name , IP , MAC , UUID , SN and Version .
Camera List	List shows the cameras discovered by the search function. Each camera shows the "IP", "Status", "Model Name" and "Device Mark". Users can also click the column headers to sort the list.
Device Mark	Asterisk sign indicates that this device has "Preview", "Assign IP" and "Firmware Upgrade" functions.

Button Functions

Function	Button	Description
Search		Discovers IP cameras available on the network.
Assign IP		Changes the IP address of the camera.
Home Page		Opens the web browser to the home page of the camera.
Firmware Upgrade		Upgrades the camera firmware.

Search

When the **[Search]** button is clicked, the application will start searching cameras on the network. To stop searching, click the **[Done]** button.

Assign IP

When the **[Assign IP]** button is clicked, a pop-up window "IP Address Configuration" will appear, providing options to use DHCP or static IP address.

Home Page

To view the home page of a particular camera, double click on the camera in the list, the web browser will open and redirect to the home page. To access the home page of two or more cameras, tick the box of the cameras you wish to view and click on the **[Home Page]** button.

Firmware Upgrade

To update the camera firmware, tick the box of the cameras you wish to update and click on the **[Firmware Upgrade]** button. Follow the on-screen prompts to complete the upgrade. If the camera does not support firmware upgrade, a pop-up window will be displayed.

NOTE: Different IP camera models use different firmwares, **please do NOT update the firmware of different models using the same firmware.**

Web Browser

1. Locate and open one of the web browsers (such as Internet Explorer, Chrome, Firefox, etc.) shortcut on the desktop.
2. In the address bar, type 192.168.0.250 (default IP address of the camera) and then press the **Enter** button.
3. You will be prompted with a pop-up window asking for login information, type in "**Admin**" (default login name) and "**1234**" (default password)
4. Once logged in, you will see the main screen.

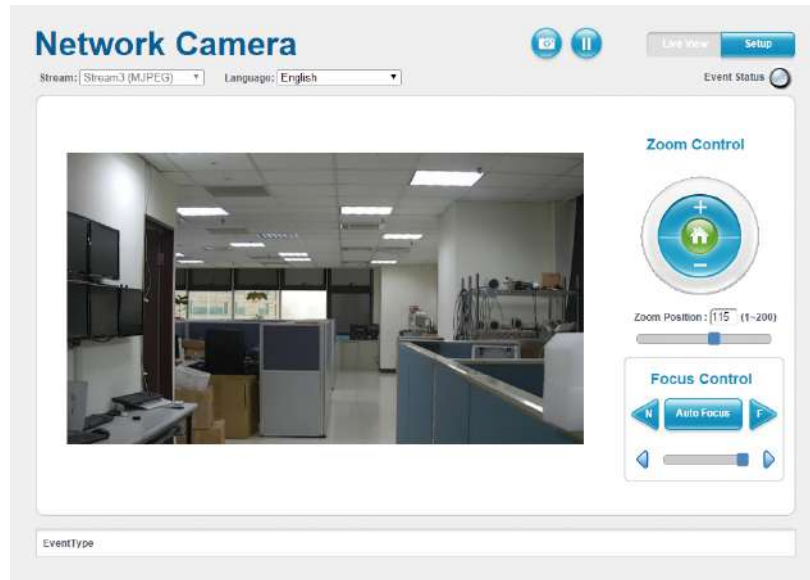

5. If no video is displayed on the screen, please make sure you have VLC Media Player installed on the computer. If not, please download and install it first, then you can see the video from the web browser.



Note: The recommended browsers to use are Internet Explorer, Safari, Firefox and Chrome. However, Chrome only supports the viewing of the web **Setup** menu; **Live View** of the video stream is not supported.

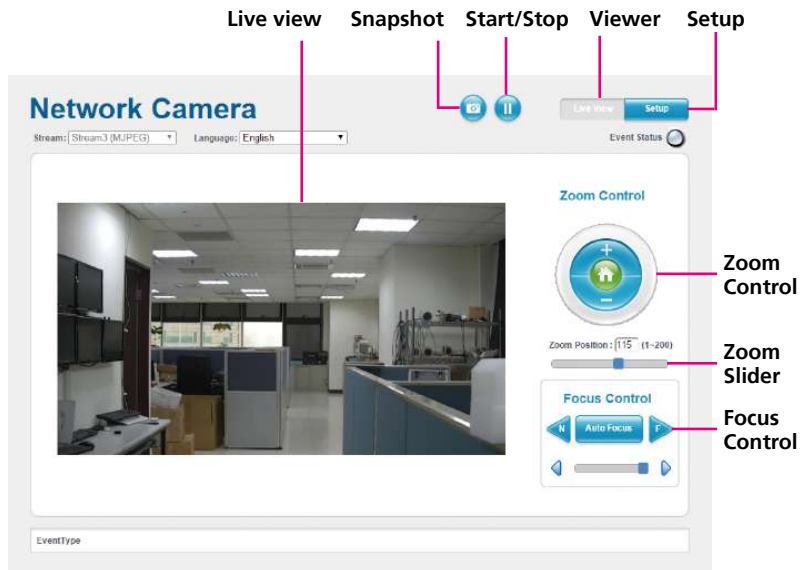

Snapshot

Takes a image snapshot from the camera, you will be prompted to store the image file onto the computer's hard drive.

Start/Stop

Press to stop the live video, press again to restart.

Viewer

Views the live video of the camera.



Setup

Options for configuring the IP camera.

Motorized Lens

Zoom Control



Buttons used to control zooming function.

Button	Description
	Returns the camera back to default position.
	Adjusts the camera to zoom in or out.

Zoom Position

Adjusts the camera's zoom level. Move the zoom slider bar left or right to adjust the zoom level. The value of the zoom position will be reflected in the text field. However, the zoom position cannot be manually entered in the text field.

Focus Control

Adjusts the camera's focus. To adjust the focus automatically, press the **Auto Focus** button. To set the focus manually, press the  to focus far objects, and  to focus near objects. The focus can also be adjusted through the slider bar.

Configuring the Camera's Setting

1. To configure the camera's setting, click on the **Setup** button on the main screen to enter the configuration menu.

Setup

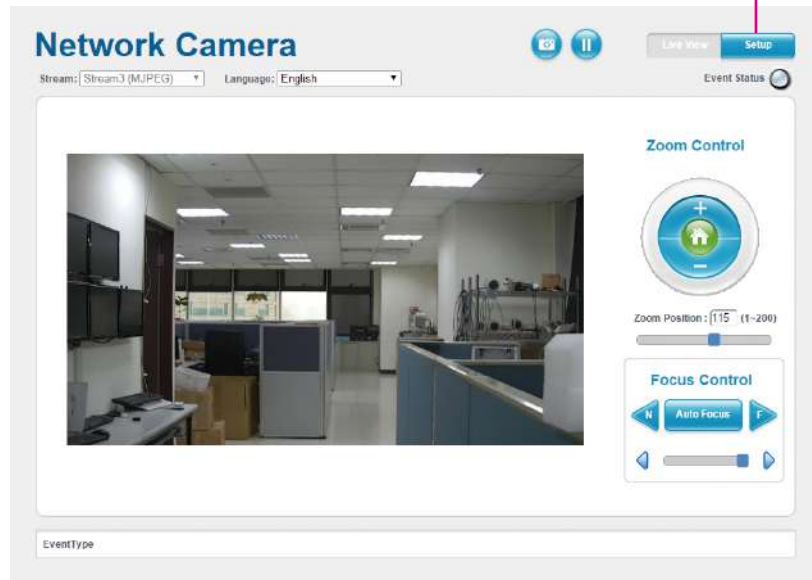

Browsing Through the Configuration Menu

The layout of the configuration menu is split into two sections. All the camera settings are located on the left hand side of the interface, clicking on them will open their corresponding sub-menu on the right.

The screenshot shows the camera configuration interface. On the left, there is a navigation menu with the following categories and sub-items:

- Video**
 - Video Configuration
- Image**
 - Exposure
 - Basic Settings
 - ROI
 - Privacy Zone
 - OSD
- Network**
 - Basic
 - FTP
 - SSL
 - SSH
 - 802.1x
 - SNMP
 - Firewall
 - LDAP
 - DDNS
 - RTSP
 - GB28181
- System**
 - Date/Time
 - Maintenance
 - User Management
- Event**
 - Alarm Handler
 - Motion Detection
 - Tampering Alarm
 - Object Detection
 - FTP Upload
 - SMTP Notification
 - Network Storage
 - Relay Handler
 - SD Record Handler

The main configuration area is titled 'Configurations' and shows settings for three streams:

- Primary Stream**
 - Codec: H.264
 - Resolution: 2592x1944
 - Rate Control: CBR
 - Frame Rate: 30 (0-30fps / Stream off = 0)
 - GOP Length: 30 (1-120)
 - Bit Rate: 4000 (64-8000kbit/s)
- Secondary Stream**
 - Codec: H.264
 - Resolution: 640x480
 - Rate Control: CBR
 - Frame Rate: 30 (0-30fps / Stream off = 0)
 - GOP Length: 30 (1-120)
 - Bit Rate: 4000 (64-8000kbit/s)
- Third Stream**
 - Resolution: 320x240
 - Quality: High
 - Frame Rate: 30 (0-30fps / Stream off = 0)

The following are the camera settings available on the left hand side:

- Video
 - Video Configuration
- Image
 - Exposure
 - Basic Settings
 - ROI
 - Privacy Zone
 - OSD
- Network
 - Basic
 - FTP
 - SSL
 - SSH
 - 802.1x
 - SNMP
 - Firewall
 - LDAP
 - DDNS
 - RTSP
 - GB28181
- System
 - Date/Time
 - Maintenance
 - User Management
- Event
 - Alarm Handler
 - Motion Detection
 - Tampering Alarm
 - Object Detection
 - FTP Upload
 - SMTP Notification
 - Network Storage
 - Relay Handler
 - SD Record Handler

Video - Video Configuration

Video Stream



Configurations

Primary Stream	Codec :	H.264
	Resolution :	2592x1944
	Rate Control :	CBR
	Frame Rate :	30 (0~30fps / Stream off = 0)
	GOP Length :	30 (1~120)
	Bit Rate :	4000 (64~8000kbit/s)
Secondary Stream	Codec :	H.264
	Resolution :	640x480
	Rate Control :	CBR
	Frame Rate :	30 (0~30fps / Stream off = 0)
	GOP Length :	30 (1~120)
	Bit Rate :	4000 (64~8000kbit/s)
Third Stream	Resolution :	320x240
	Quality :	High
	Frame Rate :	30 (0~30fps / Stream off = 0)

Primary Stream 1

Codec

Configures the format of the video stream, the options are **H.265** and **H.264**.

Resolution

Configures the resolution of the video stream. The available options are **2592x1944**, **2048x1536** and **1920x1080**.

Rate Control

Configures the Rate Control mode as **CBR** (constant bit rate) or **CVBR** (constrained variable bit rate) for the stream. Selecting **CVBR** will show the setting options for **Smart ROI**, **Smart FPS** and **Smart GOP**.

Smart ROI

Enables or disables Smart ROI feature. Enabling it will increase the bit rate of moving objects and make them clearer. Bit rate of images around the moving objects will not be modified.

Frame Rate

Adjusts the frame rate of the video stream, the range is 1~30FPS. The stream will be off if **0** is selected.

Smart FPS

Enables or disables Smart FPS feature. Enabling it will increase the FPS to 30FPS when a moving object is detected. If no moving object is detected, FPS will be reduced to save bandwidth.

GOP Length

Configures the GOP length of the stream, the range is 1~120. Users can enter the value or adjust it through the slider bar.

Video Configuration Cont.

Video Stream



Configurations

Primary Stream	Codec :	H.264
	Resolution :	2592x1944
	Rate Control :	CBR
	Frame Rate :	30 (0~30fps / Stream off = 0)
	GOP Length :	30 (1~120)
	Bit Rate :	4000 (64~8000kbit/s)
Secondary Stream	Codec :	H.264
	Resolution :	640x480
	Rate Control :	CBR
	Frame Rate :	30 (0~30fps / Stream off = 0)
	GOP Length :	30 (1~120)
	Bit Rate :	4000 (64~8000kbit/s)
Third Stream	Resolution :	320x240
	Quality :	High
	Frame Rate :	30 (0~30fps / Stream off = 0)

Smart GOP

Enables or disables Smart GOP feature. Enabling it will allow GOP to automatically increase when no moving objects are detected to save bandwidth. When moving objects are detected, GOP will automatically decrease.

Bit Rate

Configures the bit rate, the range is 64~8000. Users can enter the value or adjust it through the slider bar.

Secondary Stream

Codec

Configures the format of the video stream, the options are **H.265** and **H.264**.

Resolution

Configures the resolution of the video stream. The available options are **1280x720**, **640x480**, **640x360** and **320x240**.

Rate Control

Configures the Rate Control mode as **CBR** (constant bit rate) or **CVBR** (constrained variable bit rate) for the stream.

Frame Rate

Adjusts the frame rate of the video stream, the range is 0~30FPS. The stream will be off if **0** is selected.

GOP Length

Configures the GOP length of the stream, the range is 1~120. Users can enter the value or adjust it through the slider bar.

Bit Rate

Configures the bit rate, the range is 64~8000. User can enter the value or adjust it through the slider bar.

Video Configuration Cont.

Video Stream



Configurations

Primary Stream

Codec : H.264

Resolution : 2592x1944

Rate Control : CBR

Frame Rate : 30 (0-30fps / Stream off = 0)

GOP Length : 30 (1-120)

Bit Rate : 4000 (64-8000kbit/s)

Secondary Stream

Codec : H.264

Resolution : 640x480

Rate Control : CBR

Frame Rate : 30 (0-30fps / Stream off = 0)

GOP Length : 30 (1-120)

Bit Rate : 4000 (64-8000kbit/s)

Third Stream

Resolution : 320x240

Quality : High

Frame Rate : 30 (0-30fps / Stream off = 0)

Save

Third Stream

Resolution

Configures the resolution of the video stream. The available options are **640x360** and **320x240**.

Quality

Configures the video quality of the stream. The options are **High**, **Normal** and **Low**.

Frame Rate

Adjusts the frame rate of the video stream, the range is 1~30FPS. The stream will be off if **0** is selected.

Save

Save button to apply the configurations, click on this button once all the settings are confirmed for the new changes to take effect.

Image - Exposure

Exposure



Configurations

Profile : Day

AE Mode : Auto

Adjustment : 128 (0~255)

Iris control : 100%

Exposure Time Control : 1/15

Maximum Exposure Time : 1 / 15 (7~30)

Minimum Exposure Time : 1 / 10000 (30~20000)

Exposure Time : 1 / 30 (7~20000)

Configurations

Assists users to set up one Day profile and one Night profile.

Profile

Selects which profile (Day or Night) to configure.

AE Mode

The available options are **Auto**, **Iris priority**, **Shutter priority**, **50Hz**, **60Hz** and **Lock**.

If **Lock** is selected, then Exposure Time Control, Gain Control and BLC cannot be edited. Only Exposure Time can be edited (the range is 1/7~1/20000).

Adjustment

Adjusts the weighting from 0~255. Users can enter the value or adjust it through the slider bar.

Exposure Time Control

The available options are **OFF**, **1/30**, **1/15**, **1/7.5** and **User Define**.

Select **User Define** to enter the values of Maximum Exposure Time (the range is 1/7~1/30) and Minimum Exposure Time (the range is 1/30~1/20000) manually.

Exposure Time

The range is 1/7~1/20000. It can only be edited when **Lock** is selected as the AE Mode.

Exposure Cont.

Configurations

Profile :	Day ▾
<hr style="border: 0.5px solid #ccc;"/>	
AE Mode :	Auto ▾
Adjustment :	128 (0~255) <div style="width: 100%; height: 10px; background-color: #eee; margin-top: 5px; position: relative;"> <div style="width: 25%; height: 100%; background-color: #2196f3; position: absolute;"></div> </div>
Iris control :	100% ▾
Exposure Time Control :	1/15 ▾
Maximum Exposure Time :	1 / 15 (7~30)
Minimum Exposure Time :	1 / 10000 (30~20000)
Exposure Time :	1 / 30 (7~20000)
Gain Control :	High ▾
Gain :	1 (1~512)
BLC :	Disable ▾
WDR :	OFF ▾
AWB Mode :	Auto ▾
RG Gain :	1.00 (0.00~10.00) <div style="width: 100%; height: 10px; background-color: #eee; margin-top: 5px; position: relative;"> <div style="width: 10%; height: 100%; background-color: #2196f3; position: absolute;"></div> </div>
BG Gain :	1.00 (0.00~10.00) <div style="width: 100%; height: 10px; background-color: #eee; margin-top: 5px; position: relative;"> <div style="width: 10%; height: 100%; background-color: #2196f3; position: absolute;"></div> </div>
Defog :	OFF ▾
Noise Reduction :	Auto ▾

Gain Control

The available options are **OFF**, **Low**, **Medium**, **High** and **User Define**.

Select **User Define** to enter the value of Maximum Gain (the range is 1~512) manually.

Gain

The range is 1~512. It can only be edited when **Lock** is selected as the AE Mode.

BLC

Enables or disables backlight compensation function, enable this option if an image in the camera is too dark.

WDR

Enable this function if the camera is exposed to bright backlight, glare or high contrast lighting. The available options are **OFF**, **Auto** and **1~10 values**.

AWB Mode (Auto White Balance Mode)

White balance allows the camera to produce more accurate colors under different lighting conditions. The default setting is **Auto White Balance**, which automatically adjusts the white balance to suit the current lighting condition. You can also adjust the white balance manually through **RG Gain** or **BG Gain**. The range is 0.00~10.00.

Defog

Enable this function to remove fog or moisture. The available options are **OFF**, **Low**, **Medium** and **High**.

Noise Reduction

Enable this function to reduce noise. The available options are **OFF** and **1~11**.

Exposure Cont.



The screenshot shows a configuration window titled "Day Night Setting" with a green header. It contains four settings, each with a dropdown menu set to "Auto":

- Image Profile : Auto
- DayNight Control: Auto
- IR Control : Auto
- IR Cut Control: Auto

At the bottom center of the settings area is a blue "Save" button.

Day Night Setting

Image Profile

Select Day or Night profile to automatically set up parameters quickly. The available options are **AUTO**, **Force Day** and **Force Night**.

Day Night Control

Select the Day and Night control mode. The available options are **AUTO**, **Force Day**, **Force Night** and **Switch Schedule**.

IR Control

Select the IR control mode to use. The available options are **High**, **Medium** and **Low**.

IR Cut Control

Select the IR cut control mode to use. The available options are **Auto**, **Force Day** and **Force Night**.

Save

Save button to apply the configurations, click on this button once all the settings are confirmed for the new changes to take effect.

Note: To make configuration simple and fast, please set the day or night profiles first, then go to "Day Night Setting" and select the profile to use.

Image - Basic Settings

Basic Settings



Orientation

- Mirror :** Flip left-to-right Flip top-to-bottom
- Rotate :** Corridor

Digital Processing

- Stabilize :**
- Sharpness Adjust :** (0~255)
- Saturation Adjust :** (0~100)
- Contrast Adjust :** (0~100)

Orientation

Mirror

Flips the image horizontally (flip left-to-right) or vertically (flip top-to-bottom). They can be selected at the same time.

Rotate

Allows you to get a vertically oriented image from the camera. It is suitable for narrow corridors, hallways or aisles applications.

Digital Processing

Stabilize

Enables or disables video stabilization function. Enabling it will allow the camera to minimize the shakiness seen on the video stream (such as vibrations caused by strong winds or earthquakes).

Sharpness Adjust

Configures the sharpness of the image, the range is 0 ~ 255, with 0 being the lowest sharpness. Enter the values or adjust the bar to increase or decrease the values. The default value is 127.

Saturation Adjust

Configures the color saturation of the image, the range is 0 ~ 100, with 0 being the lowest saturation. Enter the values or adjust the bar to increase or decrease the values. The default value is 50.

Contrast Adjust

Configures the contrast of the image, the range is 0 ~ 100, with 0 being the lowest contrast. Enter the values or adjust the bar to increase or decrease the values. The default value is 50.

Basic Settings Cont.

Digital Processing

Stabilize :

Sharpness Adjust : (0~255)

Saturation Adjust : (0~100)

Contrast Adjust : (0~100)

Brightness Adjust : (0~100)

Hue Adjust : (0~100)

Brightness Adjust

Configures the brightness of the image, the range is 0 ~ 100, with 0 being the lowest brightness. Enter the values or adjust the bar to increase or decrease the values. The default value is 50.

Hue Adjust

Configures the overall hue of the image, the range is 0 ~ 100. Increasing the value will adjust the image hue towards red. Decreasing the value will adjust the image hue towards blue. The default value is 50.

Restore Settings to Defaults

Discards all the settings applied to the image and reset to the default settings.

Default All Image Settings

Discards all the settings applied to the image and revert to the previous settings.

Image - ROI

ROI



Configurations

ROI is used to select which areas will be monitored and recorded with higher image quality while using lower image quality for other non-ROI zones to save bandwidth and storage. The instructions below illustrate how to setup ROI.

1. Select Stream 1 or Stream 2 to set the ROI on.
2. There are 5 ROI zones that can be configured (zone 1 ~ zone 5). Switch to **ON** to enable ROI function. The default is **OFF**.
3. Set the image quality of the ROI in the **Level** drop-down menu, the options are **Low, Medium or High**.
4. Select the area to set the ROI by holding down the mouse button and drag to make a rectangular square, release the button once the desired area is covered.
5. Press the **Set Area** button for the setting to take effect. The ROI area will then be seen on the video stream.
6. Press the **Del Area** button or select **OFF** to delete the ROI area.

Configurations

Stream :	Stream1			
ROI Zone 1 :	<input type="checkbox"/> OFF	High	Set Area	Del Area
ROI Zone 2 :	<input type="checkbox"/> OFF	High	Set Area	Del Area
ROI Zone 3 :	<input type="checkbox"/> OFF	High	Set Area	Del Area
ROI Zone 4 :	<input type="checkbox"/> OFF	High	Set Area	Del Area
ROI Zone 5 :	<input type="checkbox"/> OFF	High	Set Area	Del Area

Image - Privacy Zone

Privacy Zone



Configurations

Configures which area of the video stream will be masked for privacy. There are 5 privacy zones that can be configured.

1. Select **ON** to enable **Privacy Zone** function. The default is **OFF**.
2. Select the area to set the privacy zone by holding down the mouse button and drag to make a rectangular square, release the button once the desired area is covered.
3. Press the **Set Area** button for the setting to take effect. The masked area will be filled with black and the label **Mask** will be seen on the video stream.
4. Press the **Del Area** button or select **OFF** to delete the privacy zone.

Configurations

Mask 1 :	<input type="checkbox"/> OFF	Set Area	Del Area
Mask 2 :	<input type="checkbox"/> OFF	Set Area	Del Area
Mask 3 :	<input type="checkbox"/> OFF	Set Area	Del Area
Mask 4 :	<input type="checkbox"/> OFF	Set Area	Del Area
Mask 5 :	<input type="checkbox"/> OFF	Set Area	Del Area

Image - OSD

OSD



General Settings

Camera Name :
Background **Translucent** **Transparent**
Text color :

Text Overlay

Top Left	<input type="button" value="OFF"/>
Top Right	<input type="button" value="OFF"/>
Bottom Left	<input type="button" value="OFF"/>
Bottom Right	<input type="button" value="OFF"/>

General Settings

Camera Name

Specifies a name for the device. The maximum length is 32 characters.

Background

Configures the background color of the text overlay, the options are **Translucent** (light grey) or **Transparent**.

Text Color

Configures the text colour as **Black**, **White**, **Green** or **Yellow**.

Text Overlay

There are 4 content positions (Top Left, Top Right, Bottom Left and Bottom Right) to display the camera name, current date/time and text overlay.

Content

OFF: The default setting is OFF.

Date/Time: Displays the current date/time.

Camera Name: Displays the device name.

Camera Name + Date/Time: Displays the device name and date/time.

Custom Text: A customized text can be specified here.

Save

Save button to apply the configurations, click on this button once all the settings are confirmed for the new changes to take effect.

Network - Basic

Network Basic

IPv4 Settings

DHCP	<input checked="" type="checkbox"/>
IP Address :	<input type="text" value="192.168.1.171"/>
Subnet Mask :	<input type="text" value="255.255.255.0"/>
Gateway :	<input type="text" value="192.168.1.254"/>
Primary DNS :	<input type="text" value="192.168.1.1"/>
Secondary DNS :	<input type="text" value="192.168.1.2"/>

System Settings

HTTP Port :	<input type="text" value="80"/>	(80, 1024-65535)
HTTPS Port :	<input type="text" value="443"/>	(443, 1024-65535)
Hardware Address :	00:10:f3:43:55:74	

IPv6 Settings

IPv6	<input checked="" type="checkbox"/>	
Link-Local :	fe80::210:f3ff:fe43:5574/64	
IPv6 Address :	<input type="text"/>	
Address Prefix :	<input type="text" value="64"/>	(0-127)
Default Route :	<input type="text"/>	
Router Advertisement :	<input checked="" type="checkbox"/>	
DNS :	<input type="text"/>	

IPv4 Settings

DHCP

Enables or disables DHCP, use this feature if the camera is connected to a network with DHCP server.

To manually configure an IP address, disable DHCP and input the IP address, subnet mask, default gateway, primary and secondary DNS server address.

System Settings

HTTP Port

Configures the HTTP port number of the web configuration menu.

HTTPS Port

Configures the HTTPS port number of the web configuration menu.

Hardware Address

Unique MAC address for each camera device.

IPv6 Settings

Enables or disables IPv6 function.

To manually input an IP address, enable IPv6 and input the address prefix, default route, enable/disable router advertisement and DNS server address.

Basic Cont.

System Settings

HTTP Port : (80, 1024-65535)
HTTPS Port : (443, 1024-65535)
Hardware Address : 00:10:f3:43:55:74

IPv6 Settings

IPv6
Link-Local : fe80::210:f3ff:fe43:5574/64
IPv6 Address :
Address Prefix : (0-127)
Default Route :
Router Advertisement :
DNS :

RTMP Settings

RTMP OFF
Url :

RTMP Settings

RTMP

Enables or disables RTMP function.

URL

Configures the web URL address.

Save

Save button to apply the configurations, click on this button once all the settings are confirmed for the new changes to take effect.

Network - FTP

FTP

Configurations

This page will enable or disable FTP access to this camera.

Enable : OFF

Username : adminftp

Password :

Re-type Password :

Max Connection : (1~10)

Save

Configurations

Enable

Enables or disables FTP access to this camera. This function is only available when an SD card is inserted. You can access files in the SD card attached to the IP camera.

Password

Specifies the FTP login password to access the IP camera.

Max Connection

Specifies the maximum number of FTP connections the IP camera can support.

Save

Save button to apply the configurations, click on this button once all the settings are confirmed for the new changes to take effect.

Network - SSL

SSL

Configurations

Mode : Disabled Optional Required

Certificate

Certificate : No certificate has been installed.

Select Certificate Install Method

- Self-Signed Certificate
- Certificate Request
- Upload Certificate

Next

Save

SSL Configurations

Mode

Disabled: Support for http only.

Optional: Support for http & https.

Required: Support for https only.

Certificate

Select Certificate Install Method

Provides options to install a new CA certification.

Save

Save button to apply the configurations, click on this button once all the settings are confirmed for the new changes to take effect.

Network - SSH

SSH

Configurations

This page will enable or disable SSH access to this camera.

Enable :

Username :

sshuser

Password :

Re-type Password :

Save

SSH Configurations

Enable

Enables or disables SSH access to this camera.

Password

Specifies the SSH login password to access the IP camera.

Save

Save button to apply the configurations, click on this button once all the settings are confirmed for the new changes to take effect.

Network - 802.1x

802.1x

802.1x Port Security

Protocol :



None
None
EAP-MD5
EAP-TLS
EAP-TTLS
EAP-PEAP

Save

802.1x Configurations

Protocol

The default is **None** to disable 802.1x function.

Select the protocols to enable 802.1x function. The available protocols are

EAP-MD5, **EAP-TLS**, **EAP-TTLS** or **EAP-PEAP**.

After the protocol has been selected, manually configure the username, password and other required information.

Save

Save button to apply the configurations, click on this button once all the settings are confirmed for the new changes to take effect.

Network - SNMP

SNMP

Configurations

No SNMP Server

SNMP V2c

Community String:

Trap Configuration

Address:

Community String:

SNMP V3

User:

Authentication: Password:

Privacy:

Trap Configuration

Address:

SNMP Configurations

No SNMP Server

Disables SNMP function.

SNMP V2c

Enables or disables SNMPv2c support.

Community String

Configures the community string.

Trap Configuration

Specifies the destination IP address to send SNMP trap messages.

SNMP V3

Enables or disables SNMPv3 support.

User

Configures the SNMPv3 username.

Authentication Mode

Configures the Authentication mode. The options are **None**, **MD5** and **SHA**.

Privacy

Configures encryption for SNMPv3. The options are **DES** and **AES**.

Trap Configuration

Specifies the destination IP address to send SNMP trap messages.

Download MIB

Download MIB file for SNMP

Save

Save button to apply the configurations, click on this button once all the settings are confirmed for the new changes to take effect.

Network - Firewall

Firewall

Configurations

Mode: OFF

Address1: Protocol: None

Address2: Protocol: None

Address3: Protocol: None

Address4: Protocol: None

Address5: Protocol: None

Address6: Protocol: None

Address7: Protocol: None

Address8: Protocol: None

Save

Firewall Configurations

Mode

Select **OFF** to disable the filtering of the specified IP address. Select **Allow** or **Deny** in the drop-down menu to specify the type of filtering rule applied to the IP address entered.

Address1 to Address8

The IP address and associated protocol (**TCP**, **UDP** or **None**) to filter can be entered here. A total of 8 IP addresses can be added to the list.

Save

Save button to apply the configurations, click on this button once all the settings are confirmed for the new changes to take effect.

Network - LDAP

LDAP

Configurations

Enable : OFF

Server :

Port : (389, 1025-65535)

Base dn :

Bind dn template :

Search dn template :

Administrator :

Operator :

Viewer :

LDAP Configurations

Enables or disables LDAP, use this feature if the camera is connected to a network with LDAP server.

After enabling LDAP, manually configure the LDAP server and other required information.

Save

Save button to apply the configurations, click on this button once all the settings are confirmed for the new changes to take effect.

Network - DDNS

DDNS

Configurations

Enable : OFF

Host Name :

DDNS Server :

User Name :

Password :

Re-type Password :

DDNS Configurations

Enable

Enables or disables DDNS service.

Hostname

Hostname of the DDNS account.

DDNS Server

Select the DDNS service provider from the drop-down menu, the available providers are **DynDNS**, **NO-IP**, and **Two-DNS**. The default option is **DynDNS**.

Username

Username of the DDNS account.

Password

Password of the DDNS account.

Re-type Password

Type the same password again for confirmation.

Save

Save button to apply the configurations, click on this button once all the settings are confirmed for the new changes to take effect.

Network - RTSP

RTSP

Configurations

Authentication :

Port : (554, 1025~65535)

Stream1 : Enable RTSP unicast stream
 Enable RTSP stream metadata
Path :
DSCP : (0~63)

Stream2 : Enable RTSP unicast stream
 Enable RTSP stream metadata
Path :
DSCP : (0~63)

Stream3 : Enable RTSP unicast stream
 Enable RTSP stream metadata
Path :
DSCP : (0~63)

RTSP Configurations

Authentication

Enables or disables verification of the account and password. The account and password are same as the camera's login account and password.

Port

Configures the port number for stream 1 to stream 3. The range is 554/1025~65535.

Stream 1 to Stream 3

Enables or disables RTSP unicast for stream 1 to stream 3. The RTSP port number and pathname for each stream can be configured here.

Default URL Path of Stream 1 to Stream 3

Stream 1: rtsp://cameraIP/stream1

Stream 2: rtsp://cameraIP/stream2

Stream 3: rtsp://cameraIP/stream3

RTSP Cont.

Multicast

Stream1 : Enable RTSP multicast stream
 Always multicast

Video IP :

Video Port : (1025~65535)

Audio IP :

Audio Port : (1025~65535)

Meta IP :

Mata Port : (1025~65535)

Path :

TTL : (1~255)

Stream2 : Enable RTSP multicast stream
 Always multicast

Video IP :

Video Port : (1025~65535)

Audio IP :

Audio Port : (1025~65535)

Meta IP :

Mata Port : (1025~65535)

Path :

TTL : (1~255)

Multicast (Stream 1 to Stream 3)

Enable RTSP Multicast

Enables or disables RTSP multicast streaming.

Always Multicast

Check this option to enable the video stream to start multicast streaming without using RTCP.

Video IP

Configures the multicast address to stream video.

Video Port

Configures the port number of the video stream.

Audio IP

Configures the multicast address to stream audio.

Audio Port

Configures the port number of the audio stream.

Meta IP

Configures the multicast address for the html meta.

Meta Port

Configures the port number of the html meta.

RTSP Cont.

Stream3: Enable RTSP multicast stream
 Always multicast

Video IP :

Video Port : (1025-65535)

Audio IP :

Audio Port : (1025-65535)

Meta IP :

Mata Port : (1025-65535)

Path :

TTL : (1-255)

Save

Path

Configures the URL address of the video stream.

TTL

Configures the time-to-live threshold of the multicast datagram before it is discarded by the router.

Save

Save button to apply the configurations, click on this button once all the settings are confirmed for the new changes to take effect.

Network - GB28181

GB28181

Configurations

Enable :	<input type="checkbox"/> OFF
SIP Server IP :	<input type="text"/>
SIP Server ID :	<input type="text" value="34020000002000000001"/>
Domain :	<input type="text" value="3401000"/>
SIP Server Port :	<input type="text" value="5060"/> (1025~65535)
Device ID :	<input type="text" value="34020000001320000001"/>
Civil Code :	<input type="text" value="650102"/>
Alarm ID :	<input type="text" value="34020000001340000010"/>
Password :	<input type="password" value="....."/>
Register Expire Time :	<input type="text" value="3600"/> (1~65535)
Heart Beat Interval :	<input type="text" value="60"/> (1~65535)
Heart Beat Max Timeout Count :	<input type="text" value="3"/> (1~65535)

Save

GB28181 Configurations

Enable

Enables or disables GB28181 settings.

After enabling GB28181, manually configure the related information for GB28181 settings.

Save

Save button to apply the configurations, click on this button once all the settings are confirmed for the new changes to take effect.

System - Date/Time

Date/Time

Display Format Setting

Display Format : 2017/01/27 20:32:55 ▾

Time Settings

Time Server :

None

DHCP

Manual

Manually setting

Synchronize with computer time

Time Zone Setting

Time zone :

Asia ▾

Taipei ▾

Save

Date/Time Configurations

Display Format

Displays the current date and time. There are various formats to select from the drop-down menu.

Time Setting

Time Server

None: Disables synchronization of the current date/time through the internet.

DHCP: If your DHCP server provides NTP server information, select this setting to enable NTP information retrieval.

Manual: Select this option to configure the NTP server address manually for date and time synchronization.

Manually setting

Manually define the date and time. The format is **yyyy/mm/dd** or **hh:mm:ss**.

Sync with computer time

Manually synchronize with the current computer date and time.

Time Zone Setting

Time Zone

Select the time zone relevant to your location in the drop-down menu.

Save

Save button to apply the configurations, click on this button once all the settings are confirmed for the new changes to take effect.

System - Maintenance

Maintenance

System Information

Firmware Version :	cam16D_01.00.0006
Model Name :	210DOAM1
Serial Number :	161200009
Mac Address :	00:10:f3:43:55:74

Firmware Update

Choose a bin file to upgrade camera.

File Name : 未選擇任何檔案

Upload

Reboot Camera

During reboot camera connection will be lost.

Reset to Default

Reset all the camera parameters to the default settings except IP address.

Reset to Factory Default

Reset all of the camera parameters to default.

Download Log File

System Information

Firmware Version

Displays the current firmware version.

Model Name

Displays the IP camera model number.

Serial Number

Displays the IP camera serial number.

MAC Address

Displays the IP camera MAC number.

Firmware Update

To update the camera's firmware, click on the **Browse** button and locate the firmware image file, once the file is selected, press the **Upload** button to begin.



During update, please do not disconnect the network cable, reset or power off the IP camera, as you may damage the device.

Reboot Camera

Click this button to reboot the camera.

Reset to Default

Click this button to restore all the camera's setting back to factory default except IP address (keeps all the settings on the **Network Basic** setting page).

Maintenance Cont.

Reset to Default
Reset all the camera parameters to the default settings except IP address.

Reset to Factory Default
Reset all of the camera parameters to default.

Download Log File

Backup

Download a full backup file of camera settings

Download Now

Restore

Choose a backup file to restore camera settings

未選擇任何檔案

Upload and Restore
NOTE: Restoring will cause the camera to restart.

Video System

Video System: NTSC PAL

Swtich Video System
NOTE: Switch video system will cause the camera to restart and reset default

Reset to Factory Default

Click this button to restore all the camera's setting back to factory default, including IP address (default is 192.168.0.250).

Download Log File

Records all the status information of the camera in list format when the camera is connecting to the PC. Downloads the log file to the computer as a text file.

Backup

Download Now

Downloads the current camera settings to a backup file.

Restore

Update and Restore

Click on the **Browse** button and locate the backup file, once the file is selected, press the **Update and Restore** button to restore camera settings.

Video System

Options to switch between NTSC or PAL video system. The camera will restart and reset to default after switching the video system.

System - User Management

The screenshot displays the 'User Management' interface with three main sections:

- User Management** (Header)
- Admin Setting** (Section):
 - Admin : admin
 - Password : [password field]
 - Re-type Password : [password field]
- User List** (Section):
 - A large empty rectangular area for displaying user accounts.
 - Buttons: 'New User' and 'Delete User'.
- User Information** (Section):
 - Access Level : Admins Views
 - Username : [text field]
 - Password : [password field]
 - Re-type Password : [password field]
 - Save button (blue)

Admin Setting

Admin

The default username is **admin**. Users cannot change it.

Password

Set up the password for administrator's authorization.

Re-type Password

Retype the same password to confirm.

User List

Displays user accounts available on the camera.

Press **New User** to add a new account and set up the authorization level of this user from the following **User Information**. Press **Give Up** to delete the new user if you do not want to set up continually.

To delete an account, press the **Delete User** button.

User Management Cont.

The screenshot displays the 'User Management' interface with three main sections:

- User Management** (Header)
- Admin Setting** (Section):
 - Admin : admin
 - Password : [password field]
 - Re-type Password : [password field]
- User List** (Section):
 - [Empty list area]
 - New User [button]
 - Delete User [button]
- User Information** (Section):
 - Access Level : Admins Views
 - Username : [text field]
 - Password : [password field]
 - Re-type Password : [password field]
 - [Save button]

User Information

This section allows users to set up each new user's authorization level. A total of ten accounts can be created for **Admins/Views**.

Access Level

Admins: Has full control (read/write) over every configuration menu item.

Views: Only has access (read) to the live view of the camera (main screen).

User Name

Username must be at least 1 and up to 16 characters.

Password

Password must be at least 1 and up to 16 characters.

Re-type Password

Retype the same password to confirm.

Save

Save button to apply the configurations, click on this button once all the settings are confirmed for the new changes to take effect.

Event - Alarm Handler

Alarm Handler

Configurations

Enable : OFF

Network Camera [Close](#)

Alarm Schedule Settings

	0	1	2	3	4	5	6	7	8	9	10	11	12	13	14	15	16	17	18	19	20	21	22	23	
Sun																									
Mon																									
Tue																									
Wed																									
Thu																									
Fri																									
Sat																									

Sun: Start: 0 : 0 End: 23 : 59

Monday: Start: 0 : 0 End: 23 : 59

Tuesday: Start: 0 : 0 End: 23 : 59

Wednesday: Start: 0 : 0 End: 23 : 59

Thursday: Start: 0 : 0 End: 23 : 59

Friday: Start: 0 : 0 End: 23 : 59

Saturday: Start: 0 : 0 End: 23 : 59

Alarm Handler Configurations

Enable

Enables or disables the alarm schedule setup.

Alarm Schedule Settings

S

Press **S** for a particular weekday to set up a 24-hour schedule automatically.

D

Press **D** for a particular weekday to clear all the previous scheduled settings automatically.

Configure the scheduled time by holding down the mouse button and clicking the time block to enable the schedule settings on the selected time. A light blue color on the time block indicates that the alarm schedule is enabled, while a light grey color indicates that the alarm schedule is disabled.

Alternatively, you can manually enter numbers to configure the hours and minutes from start to end for all weekdays.

Save

Save button to apply the configurations, click on this button once all the settings are confirmed for the new changes to take effect.

Close

Press to leave this schedule setting page.

Event - Motion Detection

Motion Detection



Configurations

Enable : OFF Monitor Motion

Sensitivity : (0~100)

Zone1 : Set Area Del Area

Zone2 : Set Area Del Area

Zone3 : Set Area Del Area

Zone4 : Set Area Del Area

Zone5 : Set Area Del Area

Motion Configurations

This section configures which area of the live video will be monitored for detecting motion.

Enable

Enables or disables motion detection function.

Sensitivity

Configures the sensitivity of motion detection, the range is 0 to 100.

Zone1 to Zone5 Setup

Configures the type of area layout to use for motion detection. You can configure up to 5 zones. The instructions below illustrate how to set up 5 zones.

1. To create zone 1, on the live video screen, select the area to set the zone by holding down the mouse button and drag to make a rectangular square, release the button once the desired area is covered.
2. Press the **Set Area** button in zone 1 to set this area as motion zone 1.
3. Repeat the above steps to create motion areas for zones 2 to 5.

To delete an area, find the motion zone number you would like to remove, and press the **Del Area** button.

Motion Detection Cont.

Network Camera
[Close](#)

Motion Schedule Settings

	0	1	2	3	4	5	6	7	8	9	10	11	12	13	14	15	16	17	18	19	20	21	22	23
Sun																								
Mon																								
Tue																								
Wed																								
Thu																								
Fri																								
Sat																								

Sunday : Start : : End : :

Monday : Start : : End : :

Tuesday : Start : : End : :

Wednesday : Start : : End : :

Thursday : Start : : End : :

Friday : Start : : End : :

Saturday : Start : : End : :

S	D
S	D
S	D
S	D
S	D
S	D
S	D

Motion Schedule Settings

S

Press **S** for a particular weekday to set up a 24-hour schedule automatically.

D

Press **D** for a particular weekday to clear all the previous scheduled settings automatically.

Configure the scheduled time by holding down the mouse button and clicking the time block to enable the schedule settings on the selected time. A light blue color on the time block indicates that the alarm schedule is enabled, while a light grey color indicates that the alarm schedule is disabled.

Alternatively, you can manually enter numbers to configure the hours and minutes from start to end for all weekdays.

Save

Save button to apply the configurations, click on this button once all the settings are confirmed for the new changes to take effect.

Close

Press to leave this schedule setting page.

Event - Tampering Alarm

Tampering Alarm

Configurations

Enable : OFF Tampering Schedule

Sensitivity : Medium

Save

[Close](#)

Network Camera

Tampering Schedule Settings

	0	1	2	3	4	5	6	7	8	9	10	11	12	13	14	15	16	17	18	19	20	21	22	23		
Sun																									S	<input type="checkbox"/>
Mon																									S	<input type="checkbox"/>
Tue																									S	<input type="checkbox"/>
Wed																									S	<input type="checkbox"/>
Thu																									S	<input type="checkbox"/>
Fri																									S	<input type="checkbox"/>
Sat																									S	<input type="checkbox"/>

Sunday : Start : : End : :

Monday : Start : : End : :

Tuesday : Start : : End : :

Wednesday : Start : : End : :

Thursday : Start : : End : :

Friday : Start : : End : :

Saturday : Start : : End : :

Save

Tampering Alarm Configurations

Enable

Enables or disables tampering alarm function.

Sensitivity

Configures the sensitivity level of tampering alarm, the options are **High**, **Medium** and **Low**.

Tampering Schedule Settings

S

Press **S** for a particular weekday to set up a 24-hour schedule automatically.

D

Press **D** for a particular weekday to clear all the previous scheduled settings automatically.

Configure the scheduled time by holding down the mouse button and clicking the time block to enable the schedule settings on the selected time. A light blue color on the time block indicates that the alarm schedule is enabled, while a light grey color indicates that the alarm schedule is disabled.

Alternatively, you can manually enter numbers to configure the hours and minutes from start to end for all weekdays.

Save

Save button to apply the configurations, click on this button once all the settings are confirmed for the new changes to take effect.

Close

Press to leave this schedule setting page.

Event - Object Detection

Object Detection



Configurations

Enable : OFF Object Schedule

Detect mode :

Setup Detection Area

Enable : OFF

Minimum Width :

Minimum Height :

Maximum Width :

Maximum Height :

Object Detection Configurations

Enable

Enables or disables object detection function.

Detect mode

Configures the methods of object detection, the options are **Line counting**, **Line crossing**, **Zone counting** and **Zone intrusion**.

Line counting: To create a **Line counting** area for calculation (no event trigger), on the live video screen, select the area by holding down the mouse button and draw the **Line counting** lines, release the button once the desired area is covered. Then select the **Two way** or **One way** option (calculation method) from the **Direction** drop-down menu.

Line crossing: To create a **Line crossing** area for triggering events, on the live video screen, select the area by holding down the mouse button and draw the **Line crossing** lines, release the button once the desired area is covered. Then select the **Two way** or **One way** option (trigger method) from the **Direction** drop-down menu. (Note: Object detection function must be enabled in the **Network Storage** menu to enable event triggers.)

Zone counting: To create a **Zone counting** area for calculation (no event trigger), on the live video screen, select the area by clicking the mouse button to specify the first anchor point, then draw a line to place the second anchor point. Continue to draw lines for the third and fourth anchor points, then finish off the selection by clicking the first anchor point. A total of 4 anchor points can be created. Select the **Inside** or **Outside** option (calculation method) from the **Direction** drop-down menu.

Object Detection Cont.

Object Detection



Configurations

Enable : OFF Object Schedule

Detect mode :

Setup Detection Area

Enable : OFF

Minimum Width :

Minimum Height :

Maximum Width :

Maximum Height :

Zone intrusion: To create a **Zone intrusion** area for triggering events, on the live video screen, select the area by clicking the mouse button to specify the first anchor point, then draw a line to place the second anchor point. Continue to draw lines for the third and fourth anchor points, then finish off the selection by clicking the first anchor point. A total of 4 anchor points can be created. Select the **Inside** or **Outside** option (trigger method) from the **Direction** drop-down menu. (Note: Object detection function must be enabled in the **Network Storage** menu to enable event triggers.)

Direction

Configures the direction of counting method.

Count

Displays the counting result.

One way for Line Counting: There will be two parallel lines (red and green). Only objects passing the green line first will be calculated and counted. If the green line is on the right, it will be counted as **Right in Count**; if the green line is on the left, it will be counted as **Left in Count**.

Two way for Line Counting: There will be two parallel lines (both green). Only objects passing the green line first will be calculated and counted. If the object passes the right green line first, it will be counted as **Right in Count**; if the object passes the left green line first, it will be counted as **Left in Count**.

Inside for Zone Counting: Objects leaving from inside the zone area to the outside will be calculated as Inside. Objects entering from outside the zone area to the inside will not be counted as **Inside** or **Outside**.

Object Detection Cont.

Configurations

Enable : OFF Object Schedule

Detect mode : Line counting

Setup Detection Area

Enable : OFF

Minimum Width :

Minimum Height :

Maximum Width :

Maximum Height :

Save

Outside for Zone Counting: Objects entering from outside the zone area to the inside will be counted as Outside. Objects leaving from inside the zone area to the outside will not be counted as **Inside** or **Outside**.

Count Reset

Resets all the counting results of Line Counting or Zone Counting to zero.

Setup Detection Area

Enable

Enables or disables the detection area for monitoring objects. When enabled, the minimum and maximum width and height of the detection area can be configured through the slider bars.

Save

Save button to apply the configurations, click on this button once all the settings are confirmed for the new changes to take effect.

Object Detection Cont.

Network Camera [Close](#)

Object Schedule Settings

	0	1	2	3	4	5	6	7	8	9	10	11	12	13	14	15	16	17	18	19	20	21	22	23
Sun																								
Mon																								
Tue																								
Wed																								
Thu																								
Fri																								
Sat																								

Sunday : Start : : End : :
 Monday : Start : : End : :
 Tuesday : Start : : End : :
 Wednesday : Start : : End : :
 Thursday : Start : : End : :
 Friday : Start : : End : :
 Saturday : Start : : End : :

Object Schedule Settings

S

Press **S** for a particular weekday to set up a 24-hour schedule automatically.

D

Press **D** for a particular weekday to clear all the previous scheduled settings automatically.

Configure the scheduled time by holding down the mouse button and clicking the time block to enable the schedule settings on the selected time. A light blue color on the time block indicates that the alarm schedule is enabled, while a light grey color indicates that the alarm schedule is disabled.

Alternatively, you can manually enter numbers to configure the hours and minutes from start to end for all weekdays.

Save

Save button to apply the configurations, click on this button once all the settings are confirmed for the new changes to take effect.

Close

Press to leave this schedule setting page.

Event - FTP Upload

FTP Upload

FTP Upload Handler

Trigger Alarm Detection : OFF

Trigger Motion Detection : OFF

Trigger Sabotage Detection : OFF

Trigger Object Detection : OFF

Trigger Scheduled : OFF

Remote Server

Host Address :

Port : (21, 1025-65535)

Username :

Password :

FTP Upload Handler Configurations

Configures which type of event trigger to enable and the FTP server address that the camera will connect to. The options are:

- Trigger Alarm Detection
- Trigger Motion Detection
- Trigger Sabotage Detection
- Trigger Object Detection
- Trigger Scheduled

Remote Server

Host Address

Specifies the host name or IP address of the FTP server.

Port

Specifies the port number of the FTP server.

Username

Specifies the login username for the FTP server.

Password

Specifies the login password for the FTP server.

Save

Save button to apply the configurations, click on this button once all the settings are confirmed for the new changes to take effect.

Event - SMTP Notification

SMTP Notification

SMTP Notification Handler

From :

Trigger Alarm Detection : OFF

Trigger Motion Detection : OFF

Trigger Sabotage Detection : OFF

Trigger Object Detection : OFF

SMTP Server

Host Address :

Port : (1~65535)

Username :

Password :

Authentication :

Recipient List

Enable	No	Email	Alarm	Motion	Sabotage	Object
<input type="checkbox"/>	1	<input type="text"/>	<input type="checkbox"/>	<input type="checkbox"/>	<input type="checkbox"/>	<input type="checkbox"/>
<input type="checkbox"/>	2	<input type="text"/>	<input type="checkbox"/>	<input type="checkbox"/>	<input type="checkbox"/>	<input type="checkbox"/>
<input type="checkbox"/>	3	<input type="text"/>	<input type="checkbox"/>	<input type="checkbox"/>	<input type="checkbox"/>	<input type="checkbox"/>
<input type="checkbox"/>	4	<input type="text"/>	<input type="checkbox"/>	<input type="checkbox"/>	<input type="checkbox"/>	<input type="checkbox"/>
<input type="checkbox"/>	5	<input type="text"/>	<input type="checkbox"/>	<input type="checkbox"/>	<input type="checkbox"/>	<input type="checkbox"/>

SMTP Notification Handler Configurations

This section configures the SMTP mail server address that the camera will use for sending emails.

From

Specifies the email address of the sender.

Trigger Event

Configures which type of event trigger to enable and the SMTP server address that the camera will connect to. The options are:

- Trigger Alarm Detection
- Trigger Motion Detection
- Trigger Sabotage Detection
- Trigger Object Detection

Message

Specifies the message content.

Subject

Specifies the subject of the message.

Attach JPEG Snapshot

Enables or disables email delivery of trigger event snapshots.

SMTP Notification Cont.

SMTP Server

Host Address :

Port : (1~65535)

Username :

Password :

Authentication : NO_AUTH ▼

Recipient List

Enable	No	Email	Alarm	Motion	Sabotage	Object
<input type="checkbox"/>	1	<input style="width: 150px;" type="text"/>	<input type="checkbox"/>	<input type="checkbox"/>	<input type="checkbox"/>	<input type="checkbox"/>
<input type="checkbox"/>	2	<input style="width: 150px;" type="text"/>	<input type="checkbox"/>	<input type="checkbox"/>	<input type="checkbox"/>	<input type="checkbox"/>
<input type="checkbox"/>	3	<input style="width: 150px;" type="text"/>	<input type="checkbox"/>	<input type="checkbox"/>	<input type="checkbox"/>	<input type="checkbox"/>
<input type="checkbox"/>	4	<input style="width: 150px;" type="text"/>	<input type="checkbox"/>	<input type="checkbox"/>	<input type="checkbox"/>	<input type="checkbox"/>
<input type="checkbox"/>	5	<input style="width: 150px;" type="text"/>	<input type="checkbox"/>	<input type="checkbox"/>	<input type="checkbox"/>	<input type="checkbox"/>
<input type="checkbox"/>	6	<input style="width: 150px;" type="text"/>	<input type="checkbox"/>	<input type="checkbox"/>	<input type="checkbox"/>	<input type="checkbox"/>
<input type="checkbox"/>	7	<input style="width: 150px;" type="text"/>	<input type="checkbox"/>	<input type="checkbox"/>	<input type="checkbox"/>	<input type="checkbox"/>
<input type="checkbox"/>	8	<input style="width: 150px;" type="text"/>	<input type="checkbox"/>	<input type="checkbox"/>	<input type="checkbox"/>	<input type="checkbox"/>
<input type="checkbox"/>	9	<input style="width: 150px;" type="text"/>	<input type="checkbox"/>	<input type="checkbox"/>	<input type="checkbox"/>	<input type="checkbox"/>
<input type="checkbox"/>	10	<input style="width: 150px;" type="text"/>	<input type="checkbox"/>	<input type="checkbox"/>	<input type="checkbox"/>	<input type="checkbox"/>

Save

SMTP Server

Host Address

Specifies the host name or IP address of the SMTP mail server.

Port Number

Specifies the port number of the SMTP mail server.

Username

Specifies the login username for the SMTP mail server.

Password

Specifies the login password for the SMTP mail server.

Authentication Mode

Specifies the SMTP server authentication mode, the options are **NO_AUTH**, **SMTP_PLAIN**, **LOGIN** and **TLS_TLS**.

Recipient List

Specifies the email address to send the email when an event is triggered by **Alarm**, **Motion**, **Sabotage** or **Object**. A maximum of 10 email addresses can be configured.

Save

Save button to apply the configurations, click on this button once all the settings are confirmed for the new changes to take effect.

Event - Network Storage

Network Storage

Network Storage Handler

Trigger Alarm Detection : OFF

Trigger Motion Detection : OFF

Trigger Sabotage Detection : OFF

Object Detection : OFF

Trigger Scheduled : OFF

Recipient Setup

Network Storage Status : not_mounted

Network address :

Share :

Record Type : Video

Login Certificate

Username :

Password :

Mount And Remove Network Storage

Mount Remove Save

Network Storage Configurations

Network Storage

This section configures the network storage server address that the camera will use when an event trigger is detected.

Trigger Event

Configures which type of event trigger to enable and the network storage server that the camera will connect to. The options are:

- Enable Trigger Alarm Detection
- Enable Trigger Motion Detection
- Enable Trigger Sabotage Detection
- Enable Object Detection
- Enable Trigger Scheduled

Recipient Setup

Network Storage Status

Displays the current connection status with the network storage server. (**not_mounted** or **ok**)

Network Address

Specifies the IP address of the network storage server.

Share

Specifies the shared folder name on the network storage server.

Record Type

Specifies the event trigger action. The options are **Snapshot** and **Video**.

Network Storage Cont.

Recipient Setup

Network Storage Status : not_mounted

Network address :

Share :

Record Type : Video

Login Certificate

Username :

Password :

Mount And Remove Network Storage

Mount Remove

Save

Login Certificate

Username and Password

Specifies the login username and password for the network storage server.

Mount and Remove Network Storage

Mount

Set up a network connection with the network storage server. All the video recordings or snapshots from event triggers will be uploaded to the network storage server. After the setting is complete, the **Network Storage Status** field will display **ok**.

Remove

Delete the previous setting or set up a new one. After the setting is removed, the **Network Storage Status** field will display **not_mounted**.

Save

Save button to apply the configurations, click on this button once all the settings are confirmed for the new changes to take effect.

Event - Relay Handler

Relay Handler

Configurations

Trigger Alarm : OFF

Trigger Motion Detection : OFF

Trigger Sabotage Detection : OFF

Trigger Object Detection : OFF

Type : ▾

Off Time : (0~30s)

Relay Handler Configurations

This section configures the event trigger options for devices connected to the DI/DO of the camera.

Trigger Alarm: When a signal is detected from **Alarm in**, the **Alarm out** will be triggered.

Trigger Motion Detection: When a motion detection event is detected, the **Alarm out** will be triggered.

Trigger Sabotage Detection: When a sabotage detection event is detected, the **Alarm out** will be triggered.

Trigger Object Detection: When an object detection event is detected, the **Alarm out** will be triggered.

Types

The options are **N.O.** and **N.C.**

Off Time

Configure the seconds from 0 to 30 seconds.

Save

Save button to apply the configurations, click on this button once all the settings are confirmed for the new changes to take effect.

Event - SD Record Handler

SD Record Handler

Configurations

Enable : OFF

Trigger Alarm Detection :

Trigger Motion Detection :

Trigger Tampering Alarm :

Trigger Object Detection :

Trigger Network Loss :

Trigger Scheduled :

SD Information

Available : 0 MBytes

Usage : 0% (0 / 0 MBytes)

Status : not_mounted

Overwrite :

Record Type : Video

SD Record Handler Configurations

Configures which type of event trigger to enable the SD recording and scheduling function. The following options are available:

- Enable Trigger Alarm Detection
- Enable Trigger Motion Detection
- Enable Trigger Tampering Alarm
- Enable Trigger Object Detection
- Enable Trigger Network Loss
- Enable Trigger Scheduled

SD Information

Available

If an SD card is installed, this section will display information on the availability of the SD card.

Usage

If an SD card is installed, this section will display the percentage of the total storage used.

Format SD Card

Formats the SD card, all data stored on the SD card will be erased if this option is used.

Status

Displays whether an SD card is installed or not. If an SD card is detected, **ok** will be displayed; if an SD card is not detected (or a faulty SD card is used), **not_mounted** will be displayed.

Overwrite

Enables or disables SD card overwrite.

Record Type

Configures the recording method to record the stream on to the SD card. The options are **Video** or **Snapshot**.

SD Record Handler Cont.

Alarm Detection Settings

Pre-event Snapshots :

Post-event Snapshots :

Pre-event Snapshot Interval : Seconds

Post-event Snapshot Interval : Seconds

FileName Prefix :

Server Path :

Tampering Alarm Settings

Pre-event Snapshots :

Post-event Snapshots :

Pre-event Snapshot Interval : Seconds

Post-event Snapshot Interval : Seconds

FileName Prefix :

Server Path :

Alarm/Motion/Tampering/Object Detection Settings Record Type Selected: Snapshot

Pre-event Snapshots

Configures the number of pre-event snapshots to upload to SD card. The options are **0, 1, 3, 5** and **10**.

Post-event Snapshots

Configures the number of post-event snapshots to upload to SD card. The options are **0, 1, 3, 5, 10, 30** and **60**.

Pre-event Snapshot Interval

Configures the interval of pre-event snapshots. The options are **1, 3, 5** and **10**.

Post-event Snapshot Interval

Configures the interval of post-event snapshots. The options are **1, 3, 5** and **10**.

FileName Prefix

Configures a prefix to append to the filename. The default prefixes for Alarm, Motion, Tamper and Object Detection are **Alarm, Motion, Tamper** and **Object** respectively.

The format of the filenames:

Alarm_yyyymmddhhmmss
Motion_yyyymmddhhmmss
Tamper_yyyymmddhhmmss
Object_yyyymmddhhmmss

Server Path

Configures a folder name on the SD card. The default folder names for Alarm, Motion, Tamper and Object Detection are **Alarm, Motion, Tamper** and **Object** respectively.

Save

Save button to apply the configurations, click on this button once all the settings are confirmed for the new changes to take effect.

SD Record Handler Cont.

Alarm Detection Settings

Pre-event Record : (1-5)

FileName Prefix :

Post-event Record : (5-100)

Server Path :

Tampering Alarm Settings

Pre-event Record : (1-5)

FileName Prefix :

Post-event Record : (5-100)

Server Path :

Alarm/Motion/Tampering/Object Detection Settings Record Type Selected: Video

Pre-event Record

Configures the length of the pre-event recording. The range is 1~5 seconds.

FileName Prefix

Configures a prefix to append to the filename. The default prefixes for Alarm, Motion, Tamper and Object Detection are **Alarm**, **Motion**, **Tamper** and **Object** respectively.

The format of the filenames:

Alarm_yyyymmddhhmmss

Motion_yyyymmddhhmmss

Tamper_yyyymmddhhmmss

Object_yyyymmddhhmmss

Post-event Record

Configures the length of the post-event recording. The range is 5~100 seconds.

Server Path

Configures a folder name on the SD card. The default folder names for Alarm, Motion, Tamper and Object Detection are **Alarm**, **Motion**, **Tamper** and **Object** respectively.

Save

Save button to apply the configurations, click on this button once all the settings are confirmed for the new changes to take effect.