



**IR Outdoor Bullet Camera
NBR126PA/ NBR526PA
User Manual**

Note: The manual is subject to change without notice

Part Number: 00125525921_190116

CONTENTS

Chapter 1: Product Introduction 1

Overview	1
Camera.....	1
Cable.....	1
Hardware Installation.....	2

Chapter 2: Camera Configuration 4

Web Browser	4
Motorized Lens	5
Configuring the Camera's Setting.....	6
Browsing Through the Configuration Menu.....	7
Video - Video Configuration	9
Primary Stream	9
Secondary Stream	10
Third Stream	11
Video - Audio Configuration.....	12
Audio Settings.....	12
Image - Exposure.....	13
Configurations	13
Day Night Setting	15
Profile Management.....	16
Image - Basic Settings	18
Orientation.....	18
Digital Processing	18
Image - ROI	20
Configurations	20
Image - Privacy Zone.....	21
Configurations	21

Image - Overlay	22
Overlay	22
Text Size	22
Network - Basic	23
IPv4 Settings	23
System Settings	23
IPv6 Settings	23
Basic Cont.	24
RTMP Settings.....	24
Link Speed.....	24
Network - FTP	25
Configurations.....	25
Network - SSL	26
SSL Configurations	26
Certificate.....	26
Network - 802.1x	27
802.1 x Configurations	27
SNMP Configurations.....	28
Network - Firewall.....	29
Firewall Configurations	29
LDAP Configurations	30
DDNS Configurations.....	31
Network - RTSP	32
RTSP Configurations	32
Multicast (Stream 1 to Stream 3)	33
Bonjour Configurations	35
Upnp Configurations	36
System - Date/Time	37
Date/Time Configurations.....	37

Content

Time Setting	37
Time Zone Setting.....	37
System - Maintenance	38
System Information	38
Firmware Update.....	38
Backup	39
Restore.....	39
Video System	39
System - User Management.....	40
Admin Setting	40
User List.....	40
User Information.....	41
Logo Graph.....	42
Event - Alarm Handler	43
Alarm Handler Configurations	43
Alarm Schedule Settings	43
Event - Motion Detection.....	44
Motion Configurations	44
Zone1 to Zone5 Setup.....	44
Motion Schedule Settings.....	45
Event - Tampering Alarm	46
Tampering Alarm Configurations.....	46
Tampering Schedule Settings	46
Event - Audio Detection	47
Audio Detection Configurations.....	47
Event - Network Loss Detection	48
Network Loss Detection Configurations.....	48
Event - FTP Upload.....	49
FTP Upload Handler Configurations	49
Remote Server.....	49
SMTP Notification Configurations.....	50
Trigger Event	50

SMTP Server.....	51
Receipt List	51
Network Storage Configurations	52
Trigger Event.....	52
Receipt List	52
Login Certificate	53
Mount and Remove Network Storage	53
Relay Handler Configurations.....	54
SD Record Handler Configurations	55
TCP Notify Configurations	57
Video Analytics - Object Detection.....	59
Configurations.....	59
Object Schedule Settings	62
Setup Detection Area Settings.....	63
Push HTTP Message Settings.....	64

CHAPTER 1: PRODUCT INTRODUCTION

Overview

Camera



Cable

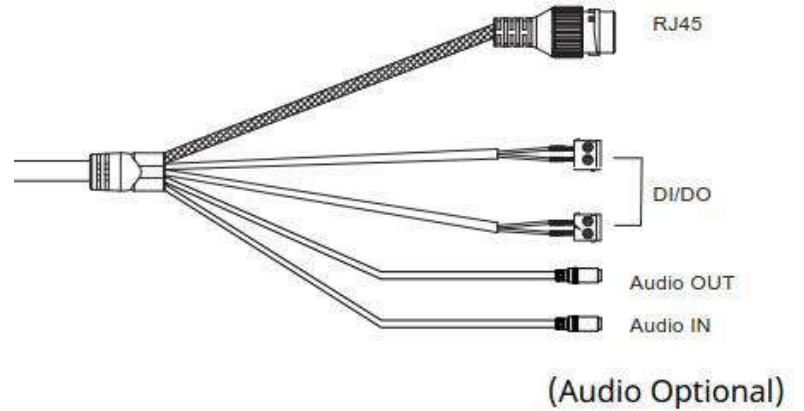

Hardware Installation

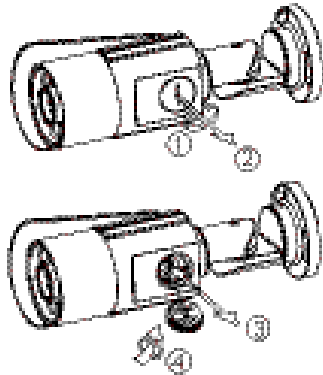

No.	Name
1	Mounting Screws
2	Wall Mount Bracket (ACB-02) W1 Kit
3	Expansion Bolts
4	Mounting Screws
5	Wall or Ceiling Surface
6	Installation Sticker

Description: The mounting surface for the bracket installation needs to withstand at least three times the total weight of the bracket and IP camera.

1. Use the 4 flat head screws to fix the metal adapter plate to the wall mount bracket.
2. Put the installation sticker on the surface (wall or ceiling) of where it will be installed.
3. Take out the screws on the bracket and put them into the expansion bolts to fix the bracket on the surface (wall or ceiling).
4. Remove the base of the camera. Use screws to fix the base onto the bracket.
5. Fix the camera back to the base secured on the bracket.

6. Adjust the direction of the camera to the desired field of view.

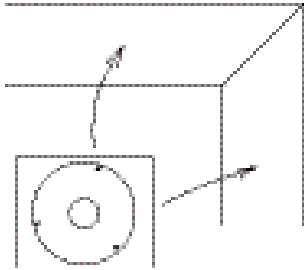

7. Put desiccant and stick it on the internal black plastic base.

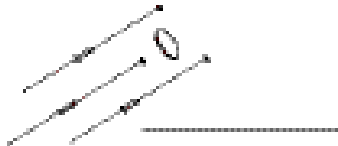

8. Put the cover back and use a hex key wrench to secure the 3 screws. Make sure all the parts of the camera are installed securely.



CHAPTER 2: CAMERA CONFIGURATION

Web Browser

1. Locate and open one of the web browsers (such as Internet Explorer, Chrome, Firefox, etc.) shortcut on the desktop.
2. In the address bar, type 192.168.0.250 (default IP address of the camera) and then press the **Enter** button.
3. You will be prompted with a pop-up window asking for login information, type in "**Admin**" (default login name) and "**1234**" (default password)

Network Camera

Username
 Admin

Password
 1234

Language
English

LOGIN

5. If no video is displayed on the screen, please make sure you have VLC Media Player installed on the computer. If not, please download and install

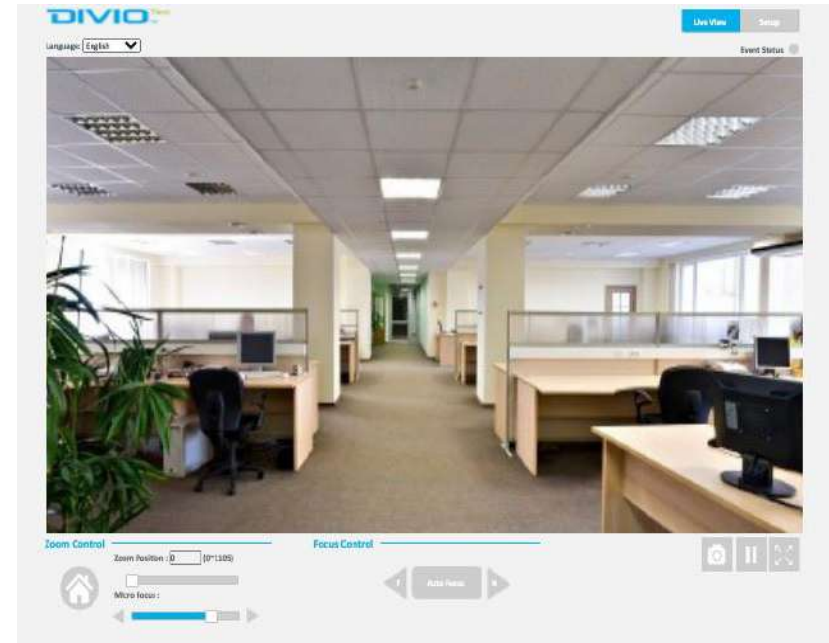

Note: It is recommended to use Chrome internet browser to get the optimized view.

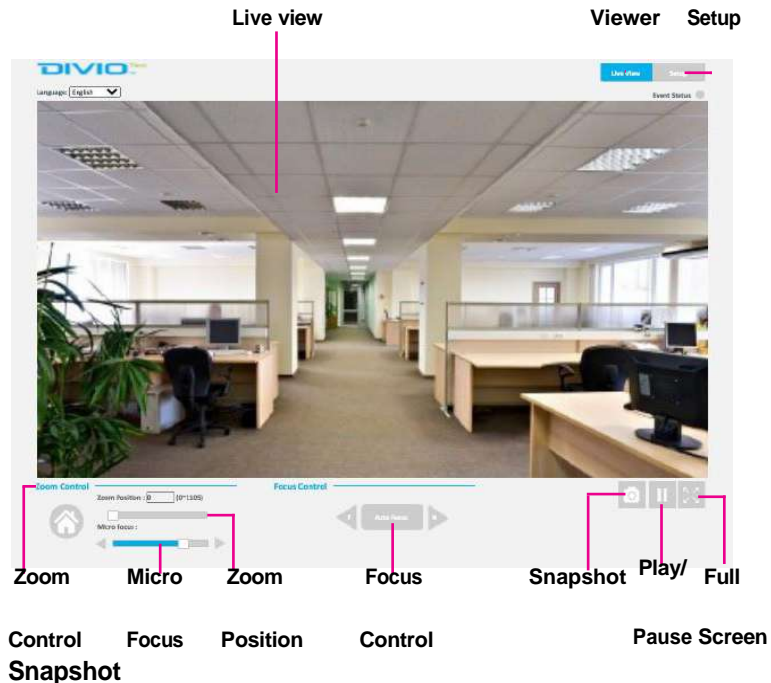

Takes a image snapshot from the camera, you will be prompted to store the image file onto the computer's hard drive.

Start/Stop

Press to stop the live video, press again to restart.

Viewer

Views the live video of the camera.

Setup

Options for configuring the IP camera.

Motorized Lens

Zoom Control



Buttons used to control zooming function.

Button	Description
	Returns the camera back to default position.

Zoom Position

Adjusts the camera's zoom level. Move the zoom slider bar left or right to adjust the zoom level. The value of the zoom position will be reflected in the text field. However, the zoom position cannot be manually entered in the text field.

Focus Control

Adjusts the camera's focus. To adjust the focus automatically, press the  button. To set the focus manually, press the  to focus far objects, and  to focus near objects. The focus can also be adjusted through the slider bar.

Micro Focus Control

Adjusts the camera's focus when the focus in Focus Control is not enough. Move the zoom slider bar left or right to adjust the focus level.



Note: It is recommended to adjust the camera back to the default position before adjusting the Zoom Position, Focus Control, and Micro Focus Control.

Configuring the Camera's Setting

1. To configure the camera's setting, click on the **Setup** button on the main

Setup

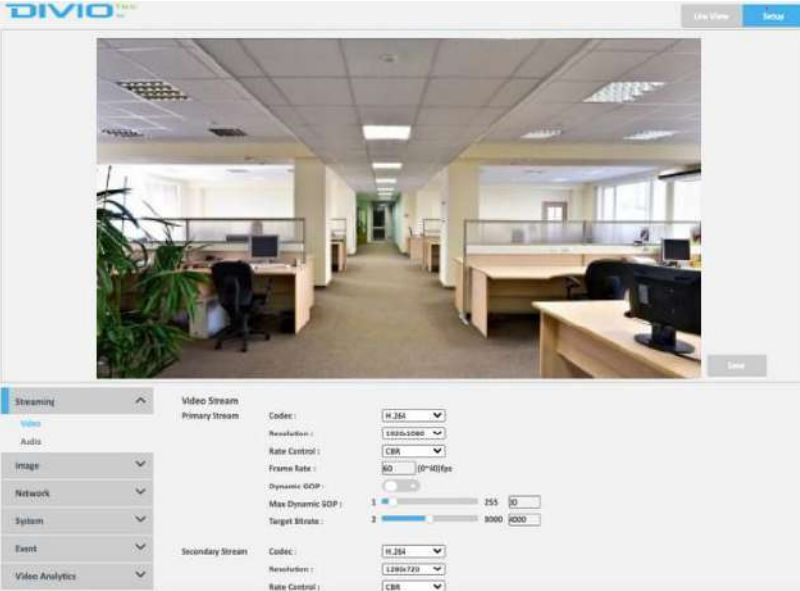

The screenshot displays the DIVIO camera configuration interface. At the top, there is a 'Live View' button and a 'Setup' button. The main area shows a live video feed of an office interior. Below the video feed, there is a 'Streaming' section with a dropdown menu for 'Video Stream'. The 'Primary Stream' settings are as follows:

- Codec: H.264
- Resolution: 1920x1080
- Rate Control: CBR
- Frame Rate: 30 (30-60fps)
- Dynamic GOP:
- Max Dynamic GOP: 1 (slider from 1 to 255) 10
- Target Bitrate: 2 (slider from 8000 to 4000) 8000

The 'Secondary Stream' settings are as follows:

- Codec: H.264
- Resolution: 1280x720
- Rate Control: CBR

Browsing Through the Configuration Menu

The layout of the configuration menu is split into two sections. All the camera settings are located on the left hand side of the interface, clicking

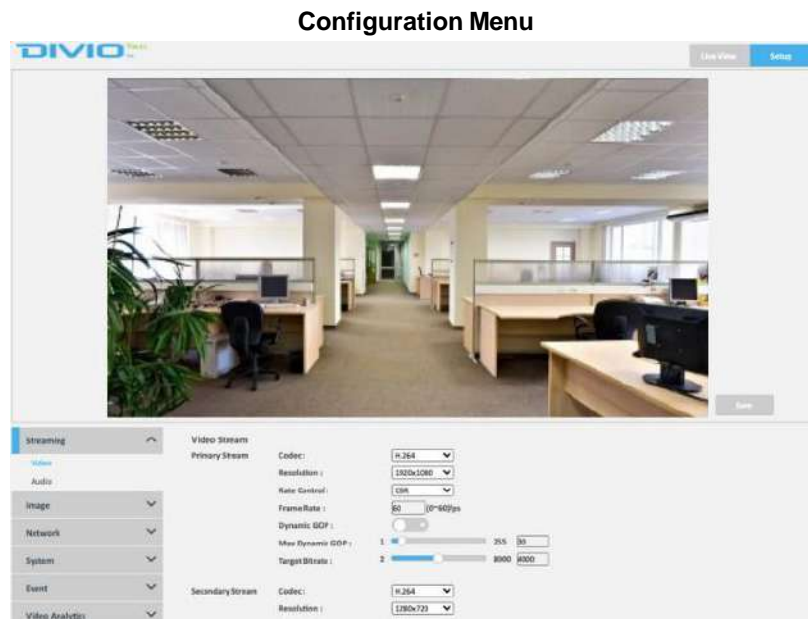

The following are the camera settings available on the left hand side for:

- Streaming
 - Video
 - Audio
- Image
 - Exposure
 - Basic Settings
 - ROI
 - Privacy Zone
 - Overlay
- Network
 - Basic
 - FTP
 - SSL
 - 802.1x
 - SNMP
 - Firewall
 - LDAP
 - DDNS
 - RTSP
 - Bonjour
 - Upnp
- System
 - Date/Time
 - Maintenance
 - User Management
 - Homepage Layout
- Event
 - Alarm Handler
 - Motion Detection
 - Tampering Alarm
 - Audio Detection
 - Network Loss Detection
 - FTP Upload
 - SMTP Notification
 - Network Storage
 - Relay Handler
 - SD Record Handler
 - TCP Notify
- Video Analytics
 - Object Detection

Video Configuration Menu

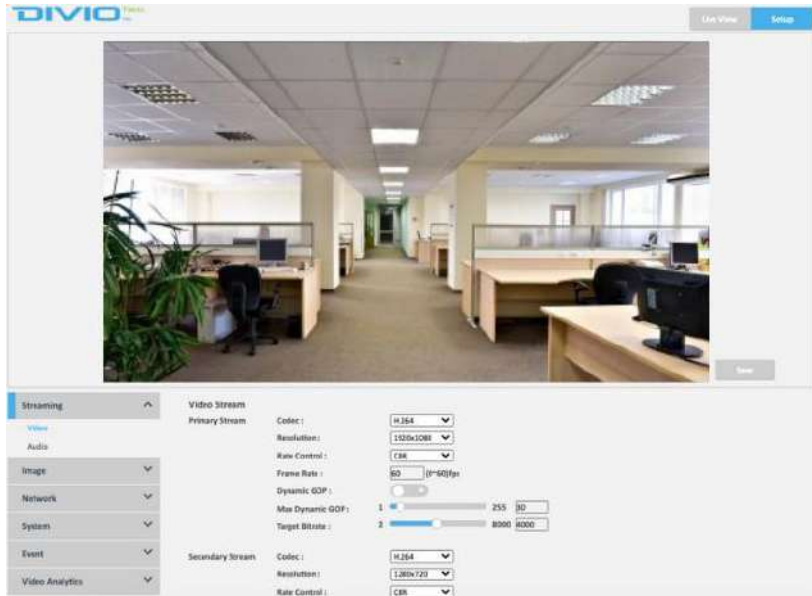

The following are the camera settings available on the left hand side for :

- Streaming
 - Video
 - Audio
- Image
 - Exposure
 - Basic Settings
 - ROI
 - Privacy Zone
 - Overlay
- Network
 - Basic
 - FTP
 - SSL
 - 802.1x
 - Firewall
 - LDAP
 - DDNS
 - RTSP
- System
 - Date/Time
 - Maintenance
 - User Management
 - Homepage Layout
- Event
 - Alarm Handler
 - Motion Detection
 - Tampering Alarm
 - Audio Detection
 - Network Loss Detection
 - FTP Upload
 - SMTP Notification
 - Network Storage
 - Relay Handler
 - SD Record Handler
 - TCP Notify
- Video Analytics
 - Object Detection

Video - Video Configuration

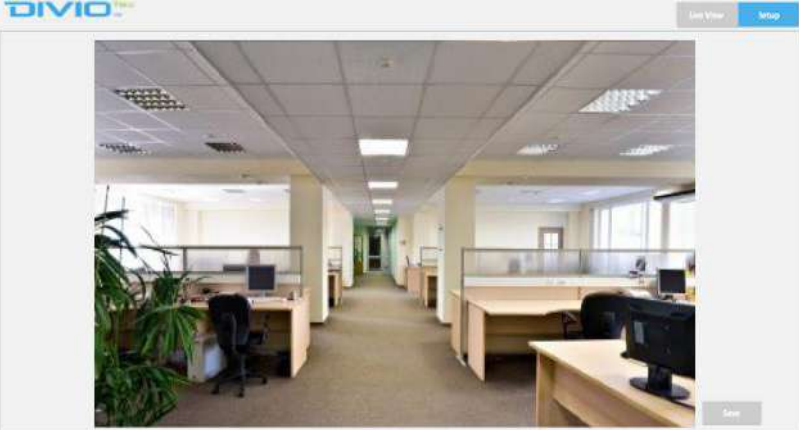

The screenshot shows the DIVIO camera configuration interface. At the top, there is a live video feed of an office interior. Below the feed, the settings are organized into two sections: 'Video Stream' and 'Secondary Stream'.

Video Stream

Primary Stream

- Codec: H.264
- Resolution: 1920x1080
- Rate Control: CBR
- Frame Rate: 60 (0~60)fps
- Dynamic GOP:
- Max Dynamic GOP: 1 255
- Target Bitrate: 2 8000

Secondary Stream

- Codec: H.264
- Resolution: 1280x720
- Rate Control: CBR

Primary Stream

Codec

Configures the format of the video stream, the options are **H.265**, **H.264**, and **MJPEG**.

Resolution

Configures the resolution of the video stream. The available options are **1920x1080** and **1280x720**.

Rate Control

Configures the Rate Control mode as **CBR** (constant bit rate) or **CVBR** (constrained variable bit rate) for the stream. Selecting **CVBR** will show the setting options for **Smart GOP**.

Frame Rate

Adjusts the frame rate of the video stream, the range is 1~60FPS for NTSC Video System, and 1~50FPS for PAL Video System (refer to System Maintenance-Video System). The stream will be off if 0 is selected.

Max Dynamic GOP

Configures the GOP length of the stream, the range is 1~255. Users can enter the value or adjust it through the slider bar.

Dynamic GOP

Enables or disables Dynamic GOP feature. Enabling it will allow GOP to automatically increase when no moving objects are detected to save bandwidth. When moving objects are detected, GOP will automatically decrease.

Video Configuration Cont.

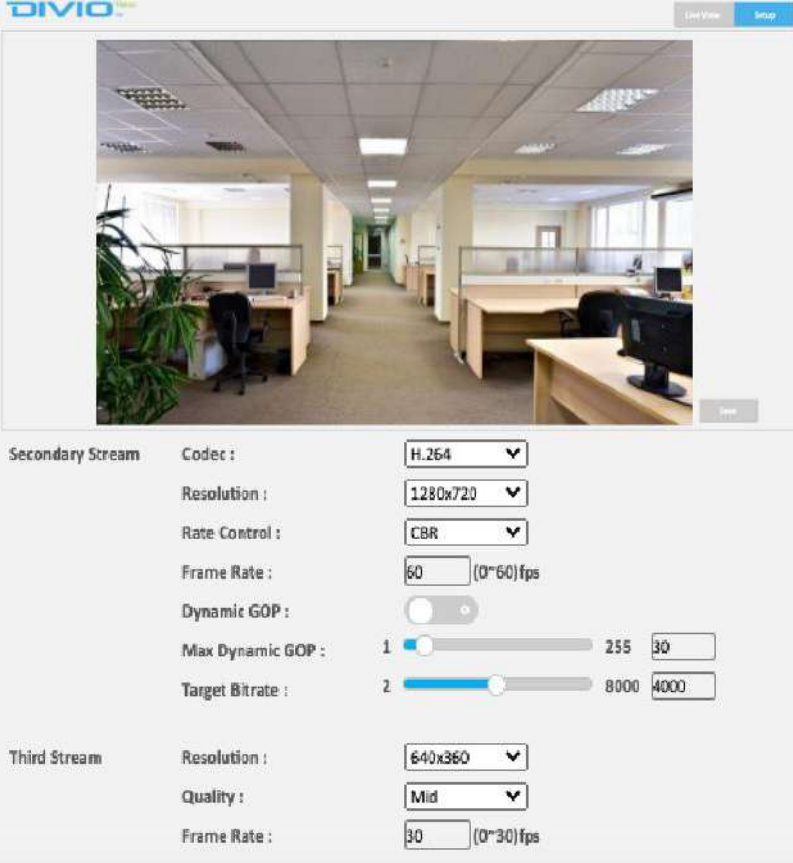

Secondary Stream

Codec : H.264

Resolution : 1280x720

Rate Control : CBR

Frame Rate : 60 (0~60) fps

Dynamic GOP :

Max Dynamic GOP : 1 255 30

Target Bitrate : 2 8000 4000

Third Stream

Resolution : 640x360

Quality : Mid

Frame Rate : 30 (0~30) fps

Target Bitrate

Configures the bit rate, the range is 2~8000. Users can enter the value or adjust it through the slider bar.

Secondary Stream

Codec

Configures the format of the video stream, the options are **H.265** and **H.264**.

Resolution

Configures the resolution of the video stream. The available options are **920x1080, 1280x720, 720x576, 720x480, 640x480, 640x360 and 320x240**.

Rate Control

Configures the Rate Control mode as **CBR** (constant bit rate) or **CVBR** (constrained variable bit rate) for the stream.

Frame Rate

Adjusts the frame rate of the video stream, the range is 1~60FPS for NTSC Video System, and 1~50FPS for PAL Video System (refer to System Maintenance-Video System). The stream will be off if 0 is selected.

Max Dynamic GOP

Configures the GOP length of the stream, the range is 1~255. Users can enter the value or adjust it through the slider bar.

Target Bitrate

Configures the bit rate, the range is 2~8000. User can enter the value or adjust it through the slider bar.

Video Configuration Cont.

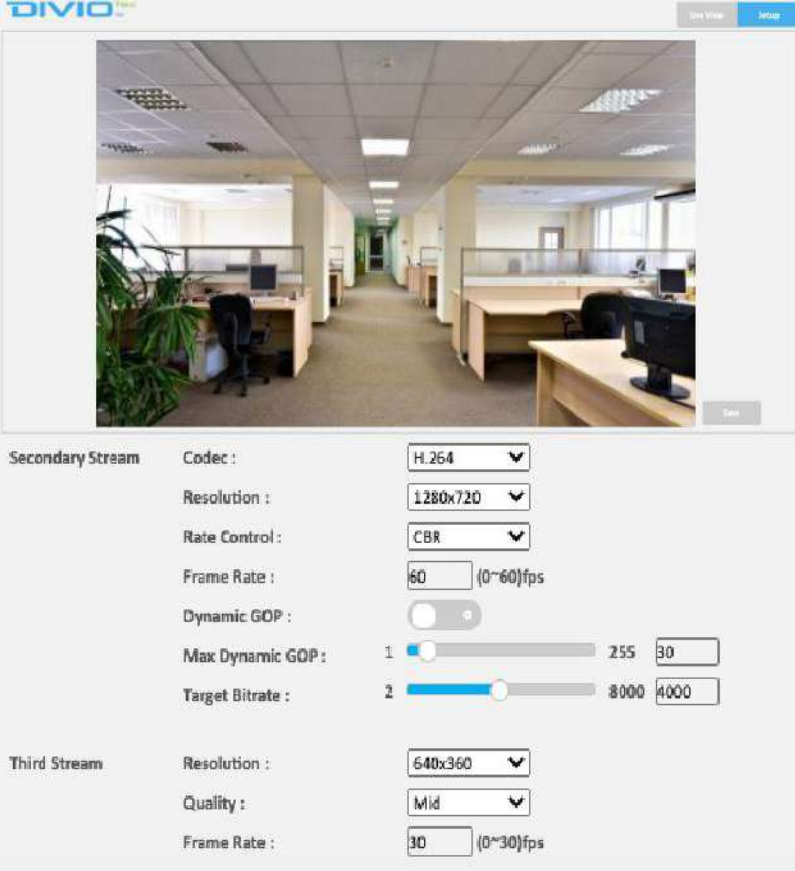

Secondary Stream

Codec : H.264

Resolution : 1280x720

Rate Control : CBR

Frame Rate : 60 (0~60)fps

Dynamic GOP :

Max Dynamic GOP : 1 255

Target Bitrate : 2 8000

Third Stream

Resolution : 640x360

Quality : Mid

Frame Rate : 30 (0~30)fps

Third Stream

Resolution

Configures the resolution of the video stream. The available options are **640x360** and **320x240**.

Quality

Configures the video quality of the stream. The options are **High**, **Mid** and **Low**.

Frame Rate

Adjusts the frame rate of the video stream, the range is 0~30FPS. The stream will be off if **0** is selected.

Save

Save button to apply the configurations, click on this button once all the settings are confirmed for the new changes to take effect.

Video - Audio Configuration

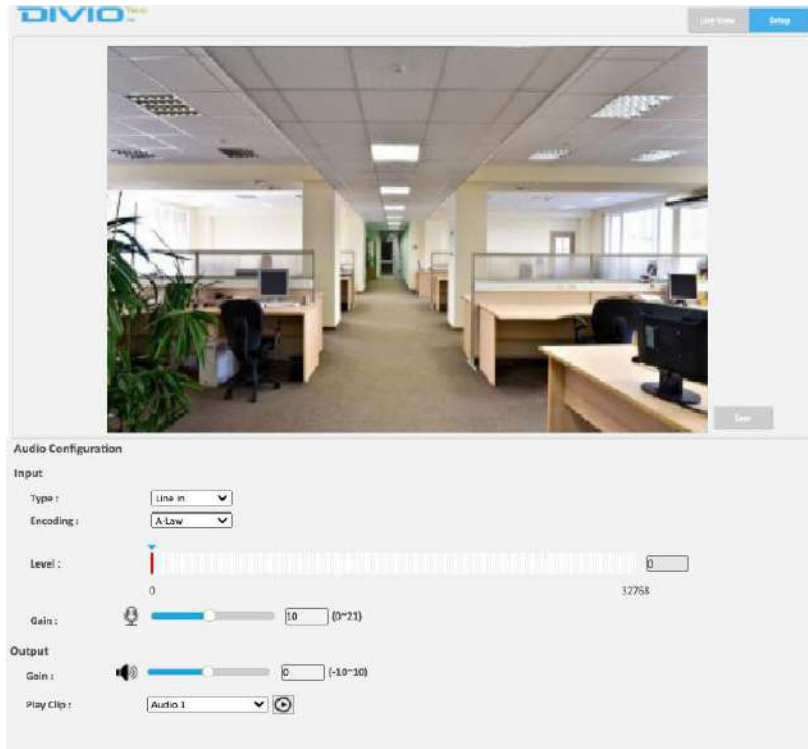

Audio Settings

Type

Select the audio configuration type of the camera. The available options are **Line in** and **Line out**.

Encoding

Adjustment of audio compression. The available options are **A-Law** and **U-Law**.

Audio Input Level

Volume adjustment for audio-in of the camera. Configures the Audio Input level of the stream, the range is 0~32768. Users can enter the value or adjust it through the slider bar.

Audio Input Gain

Volume input quality adjustment for audio-in of the camera. Configures the Audio Input gain of the stream, the range is 0~21. Users can enter the value or adjust it through the slider bar.

Audio Output Gain

Volume output quality adjustment for audio-out of the camera. Configures the Audio Output gain of the stream, the range is -10~10. Users can enter the value or adjust it through the slider bar.

Audio Output Play Clip

Select the Play Clip type of the audio. The available options are **Audio 1**, **Audio 2**, and **Audio 3**.

Image - Exposure

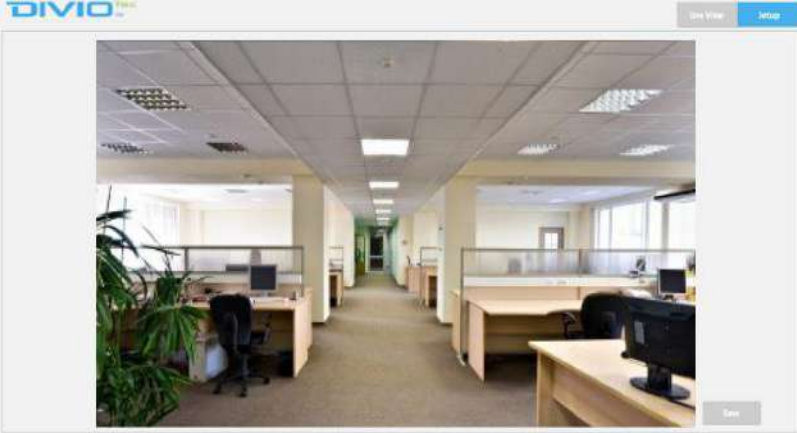

The screenshot shows the DIVIO camera configuration interface. At the top, there is a live video feed of an office hallway. Below the video feed, the 'Exposure' configuration panel is visible. The panel includes a 'Configurations' section with the following settings:

- Profile: Day
- AE Mode: Auto
- Iris control: 100%
- Adjustment: 50 (slider bar from 0 to 100)
- Exposure Time Control: 1/30
- Maximum Exposure Time: 1/30
- Minimum Exposure Time: 1/7500
- Exposure Time: 1/30

Configurations

Profile

The available options are **Day**, and **Night**.

AE Mode

The available options are **Auto**, **50Hz**, **60Hz** and **Lock**.

If **Lock** is selected, then Exposure Time Control, Gain Control and BLC cannot be edited. Only Exposure Time can be edited (the range is 1/3~1/71428).

Iris Control

The available options are **Auto**, **0%~100%** in increments of 10%.

Adjustment

Adjusts the weighting from 0~100. Users can enter the value or adjust it through the slider bar.

Exposure Time Control

The available options are **OFF**, **1/30**, **1/15** and **1/7.5**.

Exposure Time

The range is 1/3~1/71428. It can only be edited when **Lock** is selected as the AE Mode.

Exposure Cont.

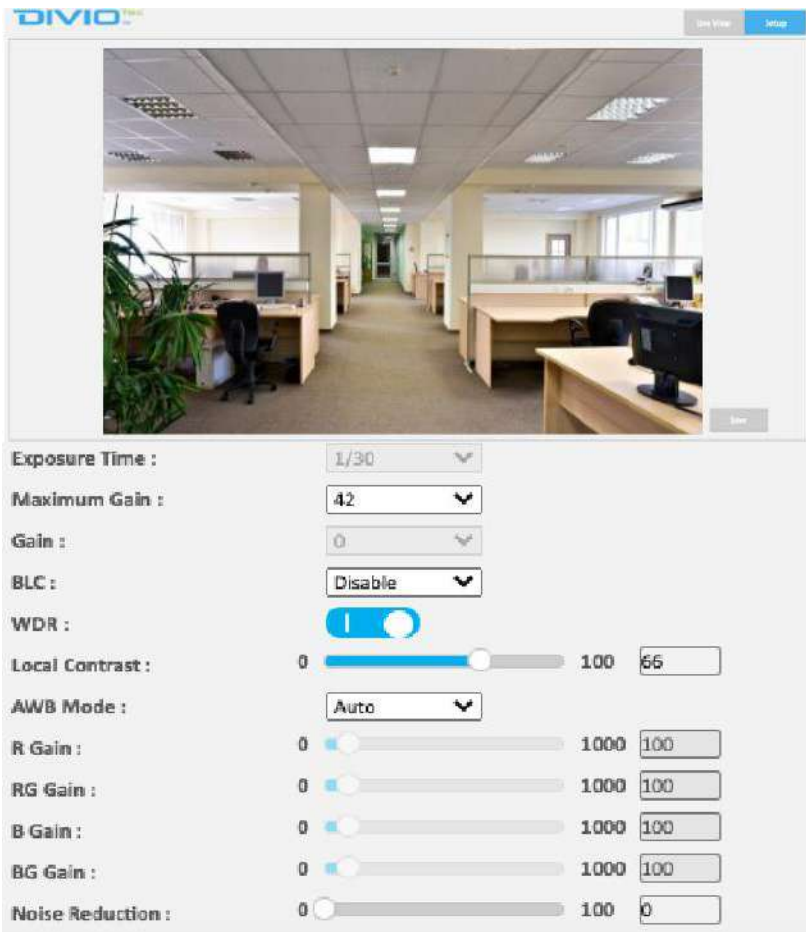

The screenshot displays the DIVIO camera configuration interface. At the top, there is a live video feed showing an office hallway. Below the feed, the control panel includes the following settings:

- Exposure Time: 1/30
- Maximum Gain: 42
- Gain: 0
- BLC: Disable
- WDR: Enabled (indicated by a blue slider)
- Local Contrast: 66 (slider bar from 0 to 100)
- AWB Mode: Auto
- R Gain: 100 (slider bar from 0 to 1000)
- RG Gain: 100 (slider bar from 0 to 1000)
- B Gain: 100 (slider bar from 0 to 1000)
- BG Gain: 100 (slider bar from 0 to 1000)
- Noise Reduction: 0 (slider bar from 0 to 100)

Maximum Gain

Select the value of Maximum Gain with the range is 0~42 with the increment of 3.

Gain

Select the value of Gain with the range is 0~42 with the increment of 3. It can only be edited when Lock is selected as the AE Mode.

BLC

Enable this function if the camera is exposed to bright backlight, in images where a bright light source is behind the subject of interest. The available options are **Enable**, and **Disable**.

WDR

Enable this function if the camera is exposed to bright backlight, glare or high contrast lighting.

Local Contrast

Adjusts the contrast level from 0~100. Users can enter the value or adjust it through the slider bar.

AWB Mode (Auto White Balance Mode)

White balance allows the camera to produce more accurate colors under different lighting conditions. The **Auto** setting is **Auto White Balance**, which automatically adjusts the white balance to suit the current lighting condition. You can also adjust the white balance manually through **R Gain**, **RG Gain**, **B Gain**, or **BG Gain**. The range is 0 ~1000.

Noise Reduction

Adjust the Noise Reduction from 0~100. Users can enter the value or adjust it through the slider bar.

Exposure Cont.

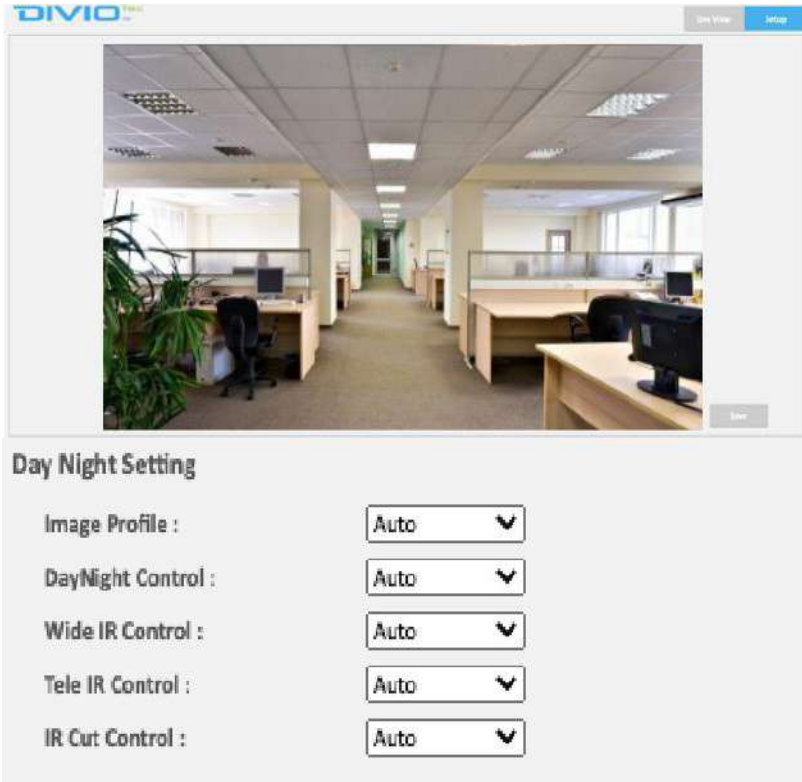

The screenshot displays the DIVIO camera configuration interface. At the top left is the 'DIVIO' logo. The main area shows a live video feed of an office hallway with desks, computers, and office chairs. Below the video feed is a 'Day Night Setting' configuration panel with five dropdown menus, all currently set to 'Auto':

- Image Profile : Auto
- DayNight Control : Auto
- Wide IR Control : Auto
- Tele IR Control : Auto
- IR Cut Control : Auto

Day Night Setting Image Profile

Select the Image Profile mode. The available options are **Auto**, **Force Day**, and **Force Night**.

Day Night Control

Select the Day and Night control mode. The available options are **Auto**, **Force Day**, **Force Night**, **Schedule**, and **Light Sensor**.

Wide IR Control

Select the IR control mode to use. The available options are **Auto**, **High**, **Mid**, **Low** and **OFF**.

Tele IR Control

Select the IR control mode to use. The available options are **Auto**, **High**, **Mid**, **Low** and **OFF**.

IR Cut Control

Select the IR cut control mode to use. The available options are **Auto**, **Force Day** and **Force Night**.

Save

Save button to apply the configurations, click on this button once all the settings are confirmed for the new changes to take effect.

Exposure Cont.

Profile Management

Profile :

Profile Rename :

Profile Access :

Profile Export :

Profile Import :

Profile All Export :

Profile All Import :

Profile Schedule Settings

Enable Profile Schedule :

Profile :

	0	1	2	3	4	5	6	7	8	9	10	11	12	13	14	15	16	17	18	19	20	21	22	23		
Sun																									S	
Mon																										S
Tue																										S
Wed																										S
Thu																										S
Fri																										S
Sat																										S

Profile Management

Adjusts multiple customized settings in one camera for different times.

Profile

Select the Profile mode. The available options are **profile1**, **profile2**, **profile3**, **profile4**, **profile5**, **profile6**, **profile7**, **profile8**, **profile9**, and **profile10**.

Profile Schedule

Select a Profile to schedule with. The available options are **profile1**, **profile2**, **profile3**, **profile4**, **profile5**, **profile6**, **profile7**, **profile8**, **profile9**, and **profile10**.

S

Press **S** for a particular weekday to set up a 24-hour schedule automatically.

Configure the scheduled time by holding down the mouse button and clicking the time block to enable the schedule settings on the selected time.

Profile Rename

Rename the Profile of your choice. Click the(save) button for the rename to take effect.

Profile Access

Select the **Save Profile** to save current exposure settings to profile of the users choices. Select the **Load Profile** to load selected profile of the users choices.

Profile Export/ All Export

Select the **Export** button to export the Profile Data of your choice/ all of the profiles.

Exposure Cont.

Profile Management

Profile :

Profile Rename :

Profile Access :

Profile Export :

Profile Import :

Profile All Export :

Profile All Import :

Profile Import/ All Import

Select the **Import** button to import the Profile Data of your choice/ all of the profiles.

Save

Save button to apply the configurations, click on this button once all the settings are confirmed for the new changes to take effect.

Image - Basic Settings

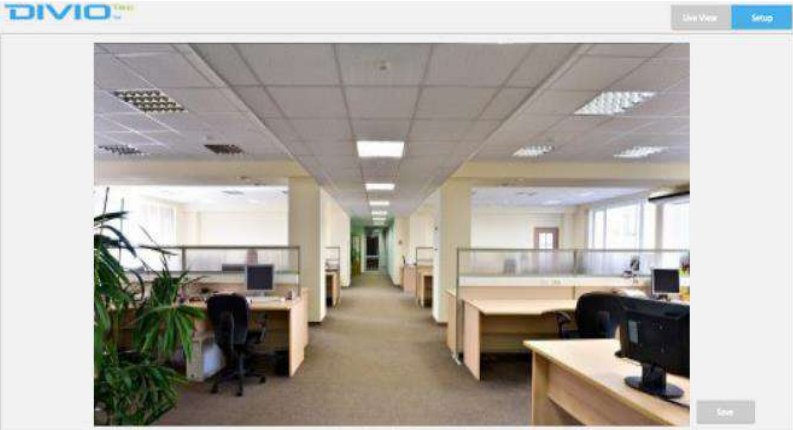

The screenshot shows the DIVIO camera configuration interface. At the top left is the DIVIO logo. To the right of the logo are 'Live View' and 'Setup' buttons. The main area is a live video feed of an office hallway. Below the video feed is a 'Basic Settings' section. Under 'Orientation', there is a 'Mirror' toggle switch (currently off) and a 'Rotate' dropdown menu with options 0, 90, 180, and 270. Under 'Digital Processing', there is a 'Stabilize' toggle switch (currently off) and five sliders for 'Sharpness Adjust', 'Saturation Adjust', 'Contrast Adjust', 'Brightness Adjust', and 'Hue Adjust'. Each slider has a range from 0 to 100 and a numerical input field set to 50.

Orientation

Mirror

Enables or Disables the mirror function on the camera.

Rotate

Allows you to rotate the image from the camera. The available options to rotate the image are **0, 90, 180, and 270**.

Digital Processing

Stabilize

Enables or disables video stabilization function. Enabling it will allow the camera to minimize the shakiness seen on the video stream (such as vibrations caused by strong winds or earthquakes).

Sharpness Adjust

Configures the sharpness of the image, the range is 0 ~ 100, with 0 being the lowest sharpness. Enter the values or adjust the bar to increase or decrease the values. The default value is 50.

Saturation Adjust

Configures the color saturation of the image, the range is 0 ~ 100, with 0 being the lowest saturation. Enter the values or adjust the bar to increase or decrease the values. The default value is 50.

Contrast Adjust

Configures the contrast of the image, the range is 0 ~ 100, with 0 being the lowest contrast. Enter the values or adjust the bar to increase or decrease the values. The default value is 50.

Basic Settings Cont.



The screenshot shows the DIVIO camera configuration interface. At the top, there is a live video feed of an office hallway. Below the feed, the settings panel is divided into two sections: "Basic Settings" and "Digital Processing".

Basic Settings

- Orientation**
 - Mirror:
 - Rotate: 0 90 180 270

Digital Processing

- Stabilize:
- Sharpness Adjust: 0 100
- Saturation Adjust: 0 100
- Contrast Adjust: 0 100
- Brightness Adjust: 0 100
- Hue Adjust: 0 100

Brightness Adjust

Configures the brightness of the image, the range is 0 ~ 100, with 0 being the lowest brightness. Enter the values or adjust the bar to increase or decrease the values. The default value is 50.

Hue Adjust

Configures the overall hue of the image, the range is 0 ~ 100. Increasing the value will adjust the image hue towards red. Decreasing the value will adjust the image hue towards blue. The default value is 50.

Restore Settings to Defaults

Discards all the settings applied to the image and reset to the default settings.

Default All Image Settings

Discards all the settings applied to the image and revert to the previous settings.

Image - ROI

ROI

Configurations

Stream :

ROI Zone 1 :

ROI Zone 2 :

ROI Zone 3 :

ROI Zone 4 :

ROI Zone 5 :

Configurations

ROI is used to select which areas will be monitored and recorded with higher image quality while using lower image quality for other non-ROI zones to save bandwidth and storage. The instructions below illustrate how to setup ROI.

1. Select Stream 1 or Stream 2 to set the ROI on.
2. There are 5 ROI zones that can be configured (zone 1 ~ zone 5). Switch to **ON** to enable ROI function. The default is **OFF**.
3. Set the image quality of the ROI in the **Level** drop-down menu, the options are **Low**, **Medium** or **High**.
4. Select the area to set the ROI by holding down the mouse button and drag to make a rectangular square, release the button once the desired area is covered.
5. Press the **Set Area** button for the setting to take effect. The ROI area will then be seen on the video stream.
6. Press the **Del Area** button or select **OFF** to delete the ROI area.

Image - Privacy Zone

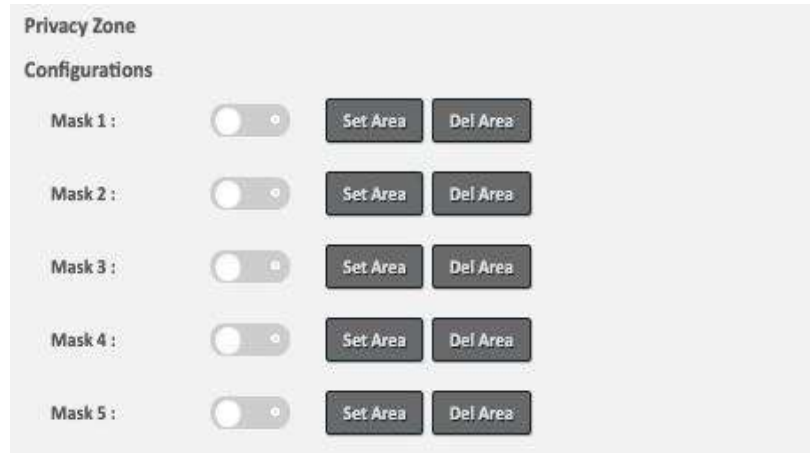

Configurations

Configures which area of the video stream will be masked for privacy. There are 5 privacy zones that can be configured.

1. Select **ON** to enable **Privacy Zone** function. The default is **OFF**.
2. Select the area to set the privacy zone by holding down the mouse button and drag to make a rectangular square, release the button once the desired area is covered.
3. Press the **Set Area** button for the setting to take effect. The masked area will be filled with black and the label **Mask** will be seen on the video stream.
4. Press the **Del Area** button or select **OFF** to delete the privacy zone.

Image - Overlay

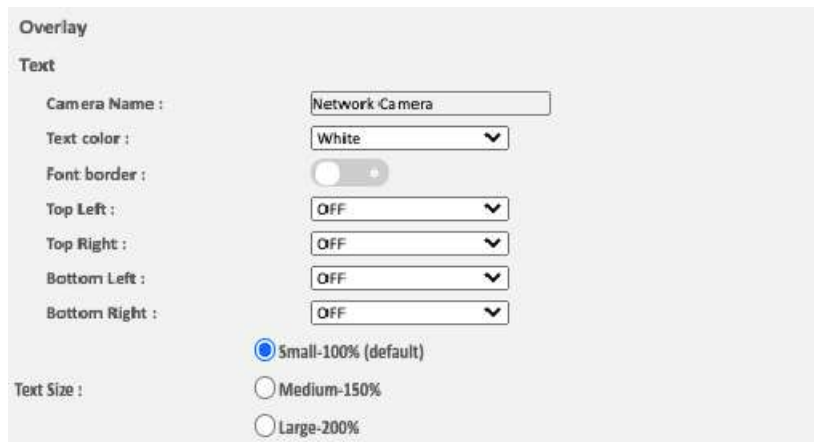

The screenshot shows the 'Overlay' configuration page. Under the 'Text' section, there are several settings:

- Camera Name :** A text input field containing 'Network Camera'.
- Text color :** A dropdown menu set to 'White'.
- Font border :** A toggle switch that is currently turned off.
- Top Left :** A dropdown menu set to 'OFF'.
- Top Right :** A dropdown menu set to 'OFF'.
- Bottom Left :** A dropdown menu set to 'OFF'.
- Bottom Right :** A dropdown menu set to 'OFF'.

Below these settings is the 'Text Size' section with three radio button options:

- Small-100% (default)
- Medium-150%
- Large-200%

Overlay

Camera Name

Specifies a name for the device. The maximum length is 32 characters.

Text Color

Configures the text colour as **White**, **Black**, **Green**, **Yellow**, or **Red**.

Font Border

Enables or Disables the Font Border function.

Content

OFF: The default setting is OFF.

Date/Time: Displays the current date/time.

Camera Name: Displays the device name.

Camera Name + Date/Time: Displays the device name and date/time.

Custom Text: A customized text can be specified here.

There are 4 content positions (Top Left, Top Right, Bottom Left and Bottom Right) to display the camera name, current date/time and text overlay.

Text Size

There are three available options of the Text Size. The available options are **Small-100%(default)**, **Medium-150%**, or **Large-200%**.

Save

Save button to apply the configurations, click on this button once all the

Network - Basic

Network Basic

IPv4 Settings

DHCP :

IP Address :

Subnet Mask :

Gateway :

Primary DNS :

Secondary DNS :

System Settings

HTTP Port : (80, 1025~65535)

HTTPS Port : (443, 1025~65535)

Hardware Address : 58:e8:76:60:55:f3

IPv6 Settings

IPv6 :

IPv6 Auto :

IPv6 Auto Mode :

Link-Local :

IPv6 Address :

Address Prefix : (0~127)

Default Route :

DNS :

IPv4 Settings

DHCP

Enables or disables DHCP, use this feature if the camera is connected to a network with DHCP server.

To manually configure an IP address, disable DHCP and input the IP address, subnet mask, default gateway, primary and secondary DNS server address.

System Settings

HTTP Port

Configures the HTTP port number of the web configuration menu.

HTTPS Port

Configures the HTTPS port number of the web configuration menu.

Hardware Address

Unique MAC address for each camera device.

IPv6 Settings

Enables or disables IPv6 function.

To manually input an IP address, enable IPv6 and input the address prefix, default route, enable/disable router advertisement and DNS server address.

Basic Cont.

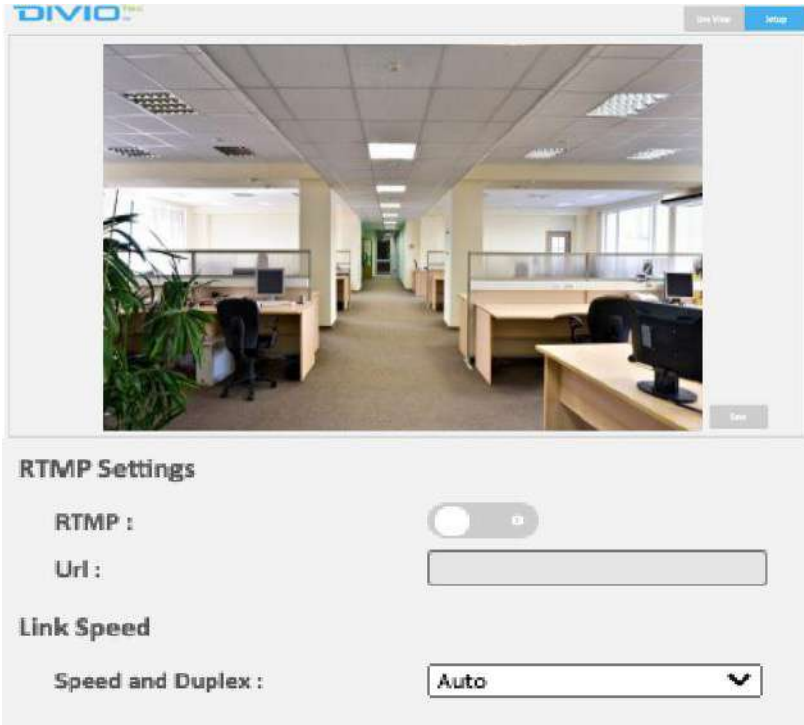

The screenshot shows the DIVIO camera configuration interface. At the top, there is a live video feed of an office hallway. Below the feed, there are two sections: "RTMP Settings" and "Link Speed".

RTMP Settings

RTMP :

Url :

Link Speed

Speed and Duplex :

RTMP Settings

Enables or disables RTMP function. Enter website link if necessary.

Link Speed

Speed and Duplex

The available options are **Auto**, **100Mbps Full Duplex**, **100Mbps Half Duplex**, **10Mbps Full Duplex**, or **10Mbps Half Duplex**.

Network - FTP



FTP

Configurations

Enable :

Username : adminftp

Password :

Re-type Password :

Max Connection : (1~10)

Configurations

Enable

Enables or disables FTP access to this camera. This function is only available when an SD card is inserted. You can access files in the SD card attached to the IP camera.

Password

Specifies the FTP login password to access the IP camera.

Max Connection

Specifies the maximum number of FTP connections the IP camera can support.

Save

Save button to apply the configurations, click on this button once all the settings are confirmed for the new changes to take effect.

Network - SSL

The screenshot shows a web interface for SSL configuration. It is divided into three main sections: 'SSL Configuration', 'Certificate', and 'Select Certificate Install Method'.
1. **SSL Configuration:** The 'Mode' is set to 'Disabled' (indicated by a selected radio button). There are also unselected radio buttons for 'Required' and 'Optional'. A 'Save' button is located below the mode selection.
2. **Certificate:** The status is 'No certificate has been installed.'
3. **Select Certificate Install Method:** There are three unselected radio button options: 'Self-Signed Certificate', 'Certificate Request', and 'Upload Certificate'. A 'Next' button is located at the bottom right of this section.

SSL Configurations

Mode

Disabled: Support for http only.

Optional: Support for http & https.

Required: Support for https only.

Certificate

Select Certificate Install Method

Provides options to install a new CA certification.

Save

Save button to apply the configurations, click on this button once all the settings are confirmed for the new changes to take effect.

Network - 802.1x

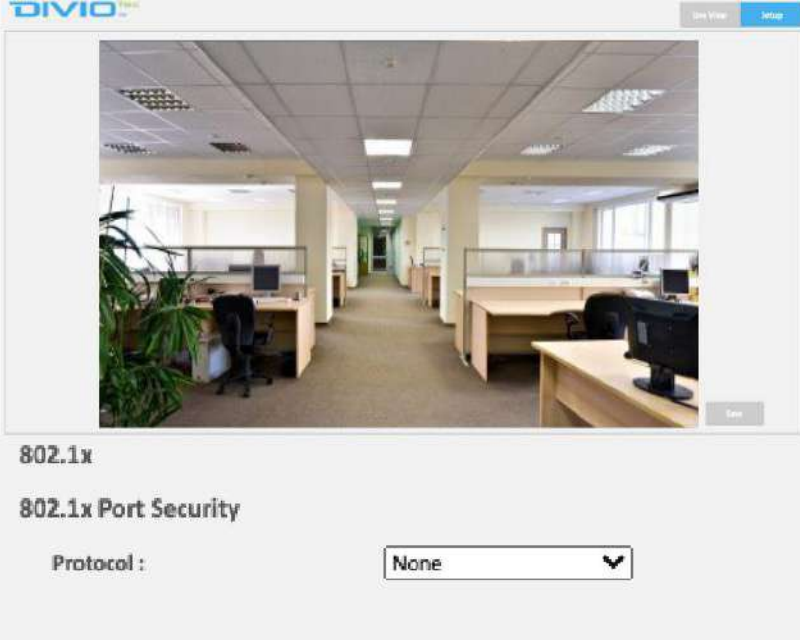

The screenshot shows the DIVIO camera configuration interface. At the top left is the DIVIO logo. Below it is a live video feed of an office hallway with cubicles. To the right of the video are buttons for 'Live View' and 'Setup'. Below the video is a 'Save' button. Underneath the video, the text '802.1x' is displayed. Below that is the section '802.1x Port Security'. Under this section, there is a label 'Protocol :' followed by a dropdown menu currently set to 'None' with a downward arrow.

802.1x Configurations Protocol

The default is **None** to disable 802.1x function. Select the protocols to enable 802.1x function. The available protocols are **EAP-MD5**, **EAP-TLS**, **EAP-TTLS** or **EAP-PEAP**.

After the protocol has been selected, manually configure the username, password and other required information.

Save

Save button to apply the configurations, click on this button once all the settings are confirmed for the new changes to take effect.

Network - SNMP

SNMP Configurations

No SNMP Server

SNMP V2c

Public Community String :

Private Community String :

Trap Configuration

Address :

Community String :

SNMP V3

User :

Authentication : Password :

Privacy : Password :

Trap Configuration

Address :

SNMP Configurations

The available options are **No SNMP Server**, **SNMP V2c**, or **SNMP V3**.

No SNMP Server

Disables SNMP function.

SNMP V2c

Enables or disables SNMPv2c support.

Community String

Configures the community string.

Trap Configuration

Specifies the destination IP address to send SNMP trap messages.

SNMP V3

Enables or disables SNMPv3 support.

User

Configures the SNMPv3 username.

Authentication Mode

Configures the Authentication mode. The options are None, MD5 andmSHA.

Privacy

Configures encryption for SNMPv3. The options are DES and AES.

Trap Configuration

Specifies the destination IP address to send SNMP trap messages.

Download MIB

Download MIB file for SNMP

Save

Save button to apply the configurations, click on this button once all the settings are confirmed for the new changes to take effect.

Network - Firewall

Firewall

Configurations

Mode :	<input type="text" value="OFF"/>	Protocol :	<input type="text" value="None"/>
Address1 :	<input type="text"/>	Protocol :	<input type="text" value="None"/>
Address2 :	<input type="text"/>	Protocol :	<input type="text" value="None"/>
Address3 :	<input type="text"/>	Protocol :	<input type="text" value="None"/>
Address4 :	<input type="text"/>	Protocol :	<input type="text" value="None"/>
Address5 :	<input type="text"/>	Protocol :	<input type="text" value="None"/>
Address6 :	<input type="text"/>	Protocol :	<input type="text" value="None"/>
Address7 :	<input type="text"/>	Protocol :	<input type="text" value="None"/>
Address8 :	<input type="text"/>	Protocol :	<input type="text" value="None"/>

Firewall Configurations

Mode

Select **OFF** to disable the filtering of the specified IP address. Select **Allow** or **Deny** in the drop-down menu to specify the type of filtering rule applied to the IP address entered.

Address1 to Address8

The IP address and associated protocol (**TCP**, **UDP** or **None**) to filter can be entered here. A total of 8 IP addresses can be added to the list.

Save

Save button to apply the configurations, click on this button once all the settings are confirmed for the new changes to take effect.

Network - LDAP

LDAP

Configurations

Enable : Off

Server :

Port : (389, 1025~65535)

Base dn :

Bind dn template :

Search dn template :

Administrator :

Operator :

Viewer :

LDAP Configurations

Enable

Enables or Disables the LDAP function.

Save

Save button to apply the configurations, click on this button once all the settings are confirmed for the new changes to take effect.

Network - DDNS

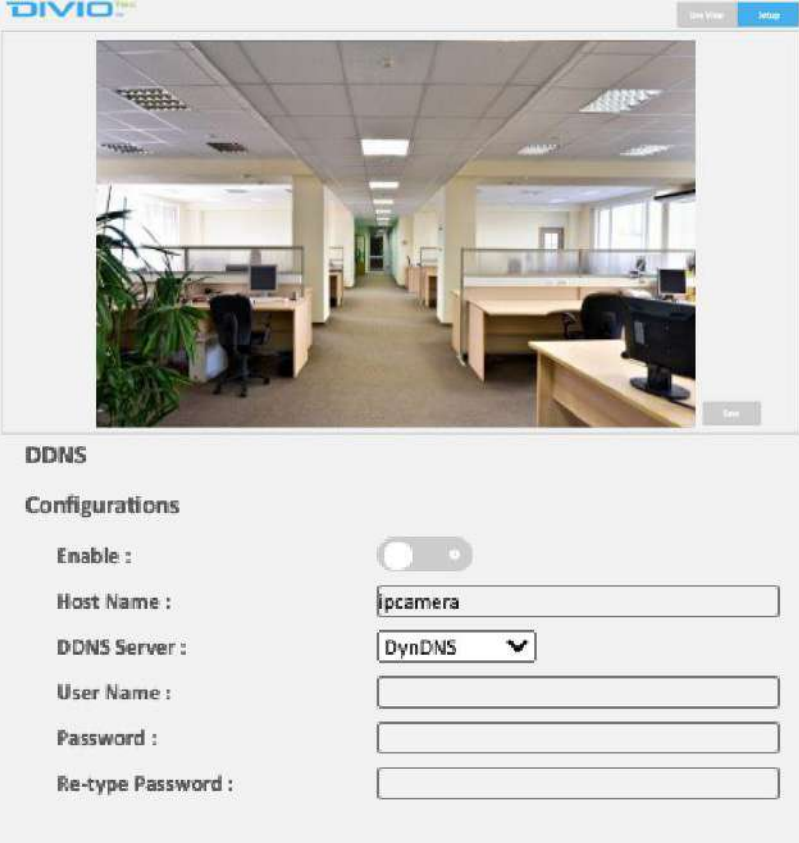

The screenshot shows the DIVIO camera configuration interface. At the top left is the DIVIO logo. To the right of the logo are two buttons: 'Live View' and 'Setup'. Below the logo is a large video feed showing a live camera view of an office hallway with desks, chairs, and cubicles. Below the video feed is a section titled 'DDNS Configurations'. This section contains a toggle switch for 'Enable', which is currently turned on. Below the toggle are five input fields: 'Host Name' (containing 'ipcamera'), 'DDNS Server' (a dropdown menu with 'DynDNS' selected), 'User Name', 'Password', and 'Re-type Password'.

DDNS Configurations

Enable

Enables or Disables the DDNS function.

Save

Save button to apply the configurations, click on this button once all the settings are confirmed for the new changes to take effect.

Network - RTSP

RTSP

Configurations

Authentication :

Port : (554,1025~65535)

Transfer Method : Average Real time

Stream1 :

Enable RTSP unicast stream

Enable RTSP stream metadata

Path :

DSCP : (0~63)

Stream2 :

Enable RTSP unicast stream

Stream2 :

Enable RTSP unicast stream

Enable RTSP stream metadata

Path :

DSCP : (0~63)

Stream3 :

Enable RTSP unicast stream

Enable RTSP stream metadata

Path :

DSCP : (0~63)

RTSP Configurations

Authentication

Enables or disables verification of the account and password. The account and password are same as the camera's login account and password.

Port

Configures the port number for stream 1 to stream 3. The range is 554/1025~65535.

Transfer Method

The available options are **Average**, or **Real Time**.

Stream 1 to Stream 3

Enables or disables RTSP unicast for stream 1 to stream 3. The RTSP port number and pathname for each stream can be configured here.

Default URL Path of Stream 1 to Stream 3

Stream 1: rtsp://cameraIP/stream1

Stream 2: rtsp://cameraIP/stream2

Stream 3: rtsp://cameraIP/stream3

RTSP Cont.

Multicast

Stream1 :

Enable RTSP multicast stream

Always multicast

Video IP :

Video Port : (1025~65535)

Audio IP :

Audio Port : (1025~65535)

Meta IP :

Meta Port : (1025~65535)

Path :

TTL : (0~255)

Stream2 :

Enable RTSP multicast stream

Always multicast

Video IP :

Video Port : (1025~65535)

Audio IP :

Audio Port : (1025~65535)

Meta IP :

Meta Port : (1025~65535)

Path :

TTL : (0~255)

Multicast (Stream 1 to Stream 3)

Enable RTSP Multicast

Enables or disables RTSP multicast streaming.

Always Multicast

Check this option to enable the video stream to start multicast streaming without using RTCP.

Video IP

Configures the multicast address to stream video.

Video Port

Configures the port number of the video stream.

Audio IP

Configures the multicast address to stream audio.

Audio Port

Configures the port number of the audio stream.

Meta IP

Configures the multicast address for the html meta.

Meta Port

Configures the port number of the html meta.

RTSP Cont.

Stream3 :

Enable RTSP multicast stream

Always multicast

Video IP :

Video Port : (1025~65535)

Audio IP :

Audio Port : (1025~65535)

Meta IP :

Mata Port : (1025~65535)

Path :

TTL : (0~255)

Path

Configures the URL address of the video stream.

TTL

Configures the time-to-live threshold of the multicast datagram before it is discarded by the router.

Save

Save button to apply the configurations, click on this button once all the settings are confirmed for the new changes to take effect.

Network - Bonjour

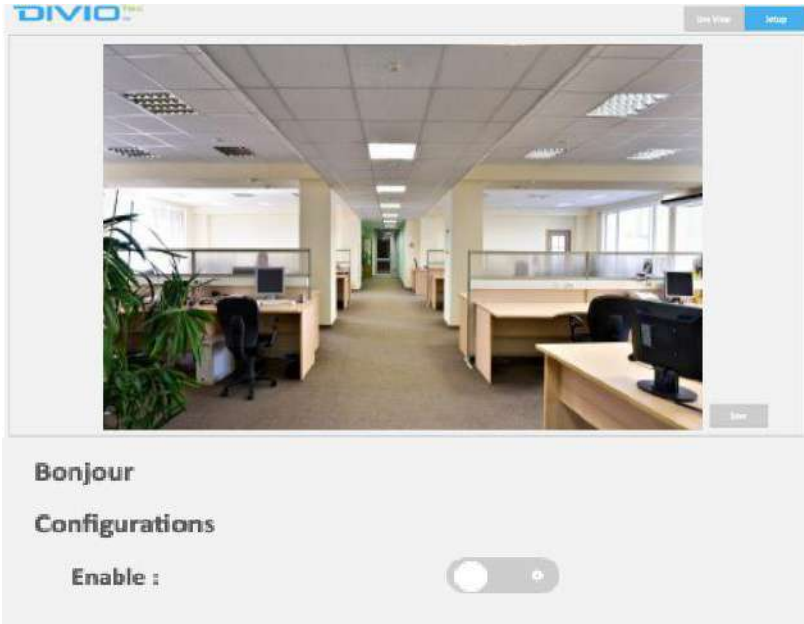

Bonjour Configurations

Enable

Enables or Disables the Bonjour function.

Network - Upnp

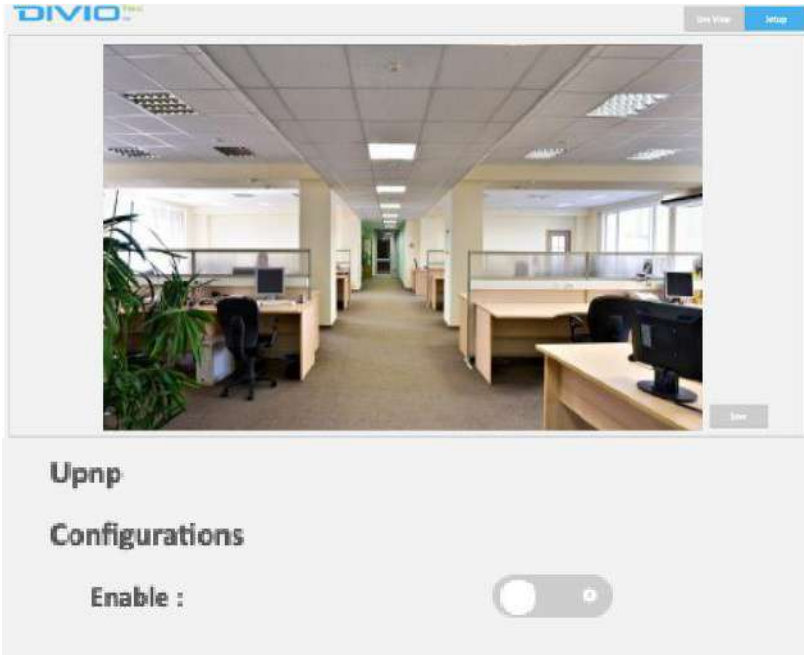

The screenshot displays a web-based camera configuration interface. At the top left, the 'DIVIO' logo is visible. The main area features a live video feed of an office hallway with desks, computers, and office chairs. Below the video feed, the text 'Upnp Configurations' is displayed, followed by a label 'Enable :' and a toggle switch that is currently turned on.

Upnp Configurations

Enable

Enables or Disables the Upnp function.

System - Date/Time

Date/Time

Current Server Time

Date : 2021/03/19 Time : 10:37:30

Display Format Setting

Display Format :

Time Settings

DHCP
 Manual
 Synchronize with computer time
 Manually setting

Time Zone Setting

Time Zone :
 ONVIF Time Zone :

Date/Time Configurations

Display Format

Displays the current date and time. There are various formats to select from the drop-down menu.

Time Setting

Time Server

DHCP: If your DHCP server provides NTP server information, select this setting to enable NTP information retrieval.

Manual: Select this option to configure the NTP server address manually for date and time synchronization.

Sync with computer time

Manually synchronize with the current computer date and time.

Manually setting

Manually define the date and time. The format is **yyyy/mm/dd** or **hh:mm:ss**.

Time Zone Setting

Time Zone

Select the time zone relevant to your location in the drop-down menu.

Save

Save button to apply the configurations, click on this button once all the settings are confirmed for the new changes to take effect.

System - Maintenance

Maintenance

System Information

Firmware Version :	camC1Q.DV0010
Model Name :	NBR126PA
Serial Number :	TSCB31002007
Mac Address :	58:e8:76:60:55:f3

Firmware Update

Choose a bin file to upgrade camera.

During reboot camera connection will be lost.

Reset all the camera parameters to the default settings except IP address.

Reset all of the camera parameters to default.

System Information

Firmware Version

Displays the current firmware version.

Model Name

Displays the IP camera model number.

Serial Number

Displays the IP camera serial number.

MAC Address

Displays the IP camera MAC number.

Firmware Update

To update the camera's firmware, click on the **Browse** button and locate the firmware image file, once the file is selected, press the **Upload** button



During update, please do not disconnect the network cable, reset or power off the IP camera, as you may damage the device.

Reboot Camera

Click this button to reboot the camera.

Reset to Default

Click this button to restore all the camera's setting back to factory default except IP address (keeps all the settings on the **Network Basic** setting page).

Maintenance Cont.

Reset all the camera parameters to the default settings except IP address.

Reset all of the camera parameters to default.

Backup

Download a full backup file of camera settings

Restore

Choose a backup file to restore camera settings

NOTE: Restoring will cause the camera to restart.

Video System

Video System : NTSC PAL

NOTE: Switch video system will cause the camera to restart and reset default

Focus

D/N Auto Focus Calibration :

NOTE: It will take time to focus during day/night switch.

Reset to Factory Default

Click this button to restore all the camera's setting back to factory default, including IP address (default is 192.168.1.168).

Download Log File

Records all the status information of the camera in list format when the camera is connecting to the PC. Downloads the log file to the computer as a text file.

Backup

Download Now

Downloads the current camera settings to a backup file.

Restore

Update and Restore

Click on the **Browse** button and locate the backup file, once the file is selected, press the **Update and Restore** button to restore camera settings.

Video System

Options to switch between NTSC or PAL video system. The camera will restart and reset to default after switching the video system.

D/N Auto Focus Calibration

Enables or disables auto focus calibration for day/night control.

System - User Management

The screenshot displays the 'User Management' interface. It is divided into three main sections:

- Admin Setting:** Contains fields for 'Admin' (pre-filled with 'Admin'), 'Password' (masked with four dots), and 'Re-type Password' (masked with four dots).
- User List:** A large empty rectangular box intended for displaying user accounts. Below it are two buttons: 'New User' and 'Delete User'.
- User Information:** Contains an 'Access Level' section with radio buttons for 'Admins' and 'Views'. Below this are three input fields for 'Username', 'Password', and 'Re-type Password'.

Admin Setting

Admin

The default username is **admin**. Users cannot change it.

Password

Set up the password for administrator's authorization.

Re-type Password

Retype the same password to confirm.

User List

Displays user accounts available on the camera.

Press **New User** to add a new account and set up the authorization level of this user from the following **User Information**. Press **Give Up** to delete the new user if you do not want to set up continually.

To delete an account, press the **Delete User** button.

User Management Cont.

The screenshot displays the 'User Management' interface. It is divided into three main sections: 'Admin Setting', 'User List', and 'User Information'.
1. **Admin Setting:** Contains three input fields: 'Admin' (with the text 'Admin' inside), 'Password' (with four asterisks), and 'Re-type Password' (with four asterisks).
2. **User List:** A large empty rectangular box. Below it are two buttons: 'New User' and 'Delete User'.
3. **User Information:** Contains four input fields. The first is 'Access Level' with two radio buttons labeled 'Admins' and 'Views'. The following three are 'Username', 'Password', and 'Re-type Password', each with an empty text box.

User Information

This section allows users to set up each new user's authorization level. A total of ten accounts can be created for **Admins/Views**.

Access Level

Admins: Has full control (read/write) over every configuration menu item.
Views: Only has access (read) to the live view of the camera (main screen).

User Name

Username must be at least 1 and up to 16 characters.

Password

Password must be at least 1 and up to 16 characters.

Re-type Password

Retype the same password to confirm.

Save

Save button to apply the configurations, click on this button once all the settings are confirmed for the new changes to take effect.

System - Homepage Layout

Logo Graph

A customized logo(GIF,JPG or PNG) can be uploaded for main page. It will be resized to 240x40 pixel to replace the previous logo.

Default Customer

 No file chosen

Logo Link :

Logo Graph

This section allows users to set up a customized logo(GIF, JPG, or PNG) for main page.

The available options are **Default**, or **Customer**.

Click on the **Choose File** button and choose the logo file, once the file is selected, press the **Upload** button to upload the logo.

Enter a website link if necessary.

Event - Alarm Handler

Alarm Handler Configurations

Enable : Alarm Schedule

Alarm Schedule Settings

	0	1	2	3	4	5	6	7	8	9	10	11	12	13	14	15	16	17	18	19	20	21	22	23			
Sun																										S	D
Mon																										S	D
Tue																										S	D
Wed																										S	D
Thu																										S	D
Fri																										S	D
Sat																										S	D

Sunday :	Start :	0	:	0	End :	23	:	59
Monday :	Start :	0	:	0	End :	23	:	59
Tuesday :	Start :	0	:	0	End :	23	:	59
Wednesday :	Start :	0	:	0	End :	23	:	59
Thursday :	Start :	0	:	0	End :	23	:	59
Friday :	Start :	0	:	0	End :	23	:	59
Saturday :	Start :	0	:	0	End :	23	:	59

Save
Close

Alarm Handler Configurations

Enable

Enables or disables the alarm schedule setup.

Alarm Schedule Settings

S

Press **S** for a particular weekday to set up a 24-hour schedule automatically.

D

Press **D** for a particular weekday to clear all the previous scheduled settings automatically.

Configure the scheduled time by holding down the mouse button and clicking the time block to enable the schedule settings on the selected time. A light blue color on the time block indicates that the alarm schedule is enabled, while a light grey color indicates that the alarm schedule is disabled.

Alternatively, you can manually enter numbers to configure the hours and minutes from start to end for all weekdays.

Save

Save button to apply the configurations, click on this button once all the settings are confirmed for the new changes to take effect.

Close

Press to leave this schedule setting page.

Event - Motion Detection

The screenshot displays the 'Motion Detection' configuration panel. At the top left, the title 'Configurations' is visible. Below it, the 'Enable' option is a blue toggle switch currently turned on. To its right is a 'Motion Schedule' button. The 'Sensitivity' is set to 30 in a text input field, with '(0~100)' indicating the range. Below the sensitivity field are five rows, each representing a motion zone (Zone 1 to Zone 5). Each zone row contains two buttons: 'Set Area' and 'Del Area'.

Motion Configurations

This section configures which area of the live video will be monitored for detecting motion.

Enable

Enables or disables motion detection function.

Sensitivity

Configures the sensitivity of motion detection, the range is 0 to 100.

Zone1 to Zone5 Setup

Configures the type of area layout to use for motion detection. You can configure up to 5 zones. The instructions below illustrate how to set up 5 zones.

1. To create zone 1, on the live video screen, select the area to set the zone by holding down the mouse button and drag to make a rectangular square, release the button once the desired area is covered.
2. Press the **Set Area** button in zone 1 to set this area as motion zone 1.
3. Repeat the above steps to create motion areas for zones 2 to 5.

To delete an area, find the motion zone number you would like to remove, and press the **Del Area** button.

Motion Detection Cont.

Motion Schedule Settings

	0	1	2	3	4	5	6	7	8	9	10	11	12	13	14	15	16	17	18	19	20	21	22	23			
Sun																										S	D
Mon																										S	D
Tue																										S	D
Wed																										S	D
Thu																										S	D
Fri																										S	D
Sat																										S	D

Sunday :	Start :	<input type="text" value="0"/> : <input type="text" value="0"/>	End :	<input type="text" value="23"/> : <input type="text" value="59"/>
Monday :	Start :	<input type="text" value="0"/> : <input type="text" value="0"/>	End :	<input type="text" value="23"/> : <input type="text" value="59"/>
Tuesday :	Start :	<input type="text" value="0"/> : <input type="text" value="0"/>	End :	<input type="text" value="23"/> : <input type="text" value="59"/>
Wednesday :	Start :	<input type="text" value="0"/> : <input type="text" value="0"/>	End :	<input type="text" value="23"/> : <input type="text" value="59"/>
Thursday :	Start :	<input type="text" value="0"/> : <input type="text" value="0"/>	End :	<input type="text" value="23"/> : <input type="text" value="59"/>
Friday :	Start :	<input type="text" value="0"/> : <input type="text" value="0"/>	End :	<input type="text" value="23"/> : <input type="text" value="59"/>
Saturday :	Start :	<input type="text" value="0"/> : <input type="text" value="0"/>	End :	<input type="text" value="23"/> : <input type="text" value="59"/>

Motion Schedule Settings

S

Press **S** for a particular weekday to set up a 24-hour schedule automatically.

D

Press **D** for a particular weekday to clear all the previous scheduled settings automatically.

Configure the scheduled time by holding down the mouse button and clicking the time block to enable the schedule settings on the selected time. A light blue color on the time block indicates that the alarm schedule is enabled, while a light grey color indicates that the alarm schedule is disabled.

Alternatively, you can manually enter numbers to configure the hours and minutes from start to end for all weekdays.

Save

Save button to apply the configurations, click on this button once all the settings are confirmed for the new changes to take effect.

Close

Press to leave this schedule setting page.

Event - Tampering Alarm

Tampering Alarm

Configurations

Enable : Tampering Schedule

Sensitivity : Mid

Tampering Schedule Settings

	0	1	2	3	4	5	6	7	8	9	10	11	12	13	14	15	16	17	18	19	20	21	22	23		
Sun																									S	D
Mon																									S	D
Tue																									S	D
Wed																									S	D
Thu																									S	D
Fri																									S	D
Sat																									S	D

Sunday :	Start :	0 : 0	End :	23 : 59
Monday :	Start :	0 : 0	End :	23 : 59
Tuesday :	Start :	0 : 0	End :	23 : 59
Wednesday :	Start :	0 : 0	End :	23 : 59
Thursday :	Start :	0 : 0	End :	23 : 59
Friday :	Start :	0 : 0	End :	23 : 59
Saturday :	Start :	0 : 0	End :	23 : 59

Tampering Alarm Configurations

Enable

Enables or disables tampering alarm function.

Sensitivity

Configures the sensitivity level of tampering alarm, the options are **High**, **Mid** and **Low**.

Tampering Schedule Settings

S

Press **S** for a particular weekday to set up a 24-hour schedule automatically.

D

Press **D** for a particular weekday to clear all the previous scheduled settings automatically.

Configure the scheduled time by holding down the mouse button and clicking the time block to enable the schedule settings on the selected time. A light blue color on the time block indicates that the alarm schedule is enabled, while a light grey color indicates that the alarm schedule is disabled.

Alternatively, you can manually enter numbers to configure the hours and minutes from start to end for all weekdays.

Save

Save button to apply the configurations, click on this button once all the settings are confirmed for the new changes to take effect.

Close

Press to leave this schedule setting page.

Event - Audio Detection



Audio Detection Configurations

Enable

Enables or disables audio detection function.

Mode

The available options are **Above**, or **Under**.

Threshold

Configures the threshold of audio detected, the range is 0 ~ 32768, with 0 being the lowest. Enter the values or adjust the bar to increase or decrease the values. The default value is 16107.

Audio Volume

Shows the volume of the audio detected.

Save

Save button to apply the configurations, click on this button once all the settings are confirmed for the new changes to take effect.

Event - Network Loss Detection

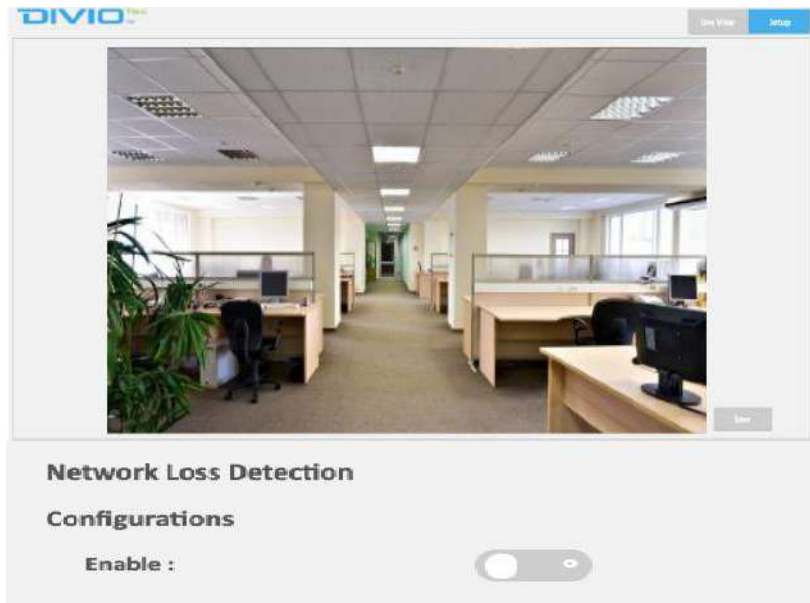

Network Loss Detection Configurations

Enable

Enables or disables network loss detection function.

Save

Save button to apply the configurations, click on this button once all the settings are confirmed for the new changes to take effect.

Event - FTP Upload

FTP Upload

FTP Upload Handler

Enable :

Trigger Alarm Detection :

Trigger Motion Detection :

Trigger Tampering Detection :

Trigger Object Detection :

Trigger Audio Detection :

Trigger Scheduled :

RemoteServer

Host Address :

Port : (21,1025~65535)

Username :

Password :

Image Destination : ▼

FTP Upload Handler Configurations

Configures which type of event trigger to enable and the FTP server address that the camera will connect to. The options are:

- Trigger Alarm Detection
- Trigger Motion Detection
- Trigger Tampering Alarm
- Trigger Object Detection
- Trigger Scheduled

Remote Server

Host Address

Specifies the host name or IP address of the FTP server.

Port

Specifies the port number of the FTP server.

Username

Specifies the login username for the FTP server.

Password

Specifies the login password for the FTP server.

Image Destination

The available options are **Single Folder**, or **Sub Folder**.

Save

Save button to apply the configurations, click on this button once all the settings are confirmed for the new changes to take effect.

Event - SMTP Notification

SMTP Notification

SMTP Notification Handler

Trigger Alarm Detection :

Trigger Motion Detection :

Trigger Tampering Detection :

Trigger Object Detection :

Trigger Audio Detection :

SMTP Server

From :

Host Address :

Port : (25, 465, 587, 1025~65535)

Username :

Password :

Authentication : ▼

SMTP Notification Configurations

This section configures the SMTP mail server address that the camera will use for sending emails.

From

Specifies the email address of the sender.

Trigger Event

Configures which type of event trigger to enable and the SMTP server address that the camera will connect to. The options are:

- Trigger Alarm Detection
- Trigger Motion Detection
- Trigger Tempering Detection
- Trigger Object Detection
- Trigger Audio Detection

Message

Specifies the message content.

Subject

Specifies the subject of the message.

Attach JPEG Snapshot

Enables or disables email delivery of trigger event snapshots.

Save

Save button to apply the configurations, click on this button once all the settings are confirmed for the new changes to take effect.

SMTP Notification Cont.

SMTP Server

From :

Host Address :

Port : (25, 465, 587, 1025~65535)

Username :

Password :

Authentication : ▼

Recipient List

Enable	No	Email	Alarm	Motion	Tampering	Object	Audio
<input type="checkbox"/>	1	<input type="text"/>	<input type="checkbox"/>	<input type="checkbox"/>	<input type="checkbox"/>	<input type="checkbox"/>	<input type="checkbox"/>
<input type="checkbox"/>	2	<input type="text"/>	<input type="checkbox"/>	<input type="checkbox"/>	<input type="checkbox"/>	<input type="checkbox"/>	<input type="checkbox"/>
<input type="checkbox"/>	3	<input type="text"/>	<input type="checkbox"/>	<input type="checkbox"/>	<input type="checkbox"/>	<input type="checkbox"/>	<input type="checkbox"/>
<input type="checkbox"/>	4	<input type="text"/>	<input type="checkbox"/>	<input type="checkbox"/>	<input type="checkbox"/>	<input type="checkbox"/>	<input type="checkbox"/>
<input type="checkbox"/>	5	<input type="text"/>	<input type="checkbox"/>	<input type="checkbox"/>	<input type="checkbox"/>	<input type="checkbox"/>	<input type="checkbox"/>
<input type="checkbox"/>	6	<input type="text"/>	<input type="checkbox"/>	<input type="checkbox"/>	<input type="checkbox"/>	<input type="checkbox"/>	<input type="checkbox"/>
<input type="checkbox"/>	7	<input type="text"/>	<input type="checkbox"/>	<input type="checkbox"/>	<input type="checkbox"/>	<input type="checkbox"/>	<input type="checkbox"/>
<input type="checkbox"/>	8	<input type="text"/>	<input type="checkbox"/>	<input type="checkbox"/>	<input type="checkbox"/>	<input type="checkbox"/>	<input type="checkbox"/>
<input type="checkbox"/>	9	<input type="text"/>	<input type="checkbox"/>	<input type="checkbox"/>	<input type="checkbox"/>	<input type="checkbox"/>	<input type="checkbox"/>
<input type="checkbox"/>	10	<input type="text"/>	<input type="checkbox"/>	<input type="checkbox"/>	<input type="checkbox"/>	<input type="checkbox"/>	<input type="checkbox"/>

SMTP Server

This section configures the SMTP mail server address that the camera will use for sending emails.

From

Specifies the email address of the sender.

Host Address

Specifies the host name or IP address of the SMTP mail server.

Port Number

Specifies the port number of the SMTP mail server.

Username

Specifies the login username for the SMTP mail server.

Password

Specifies the login password for the SMTP mail server.

Specifies the SMTP server authentication mode, the options are **NO_AUTH**, **SMTP_PLAIN**, **LOGIN** and **TLS_TLS**.

Recipient List

Specifies the email address to send the email when an event is triggered by **Alarm**, **Motion**, **Tampering** or **Object**. A maximum of 10 email addresses can be configured.

Save

Event - Network Storage

Network Storage

Network Storage Handler

Enable :

Trigger Alarm Detection :

Trigger Motion Detection :

Trigger Tampering Detection :

Trigger Object Detection :

Trigger Audio Detection :

Trigger Scheduled :

Recipient Setup

Network Storage Status : not_mounted

Network address :

Share :

Record Type : Video

Login Certificate

Username :

Password :

Mount And Remove Network Storage

Network Storage Configurations

Network Storage

This section configures the network storage server address that the camera will use when an event trigger is detected.

Trigger Event

Configures which type of event trigger to enable and the network storage server that the camera will connect to. The options are:

- Enable Trigger Alarm Detection
- Enable Trigger Motion Detection
- Enable Trigger Tampering Detection
- Enable Object Detection
- Enable Audio Detection
- Enable Trigger Scheduled

Receipient List

Network Storage Status

Displays the current connection status with the network storage server. (**not_mounted** or **ok**)

Network Address

Specifies the IP address of the network storage server.

Share

Specifies the shared folder name on the network storage server.

Record Type

Specifies the event trigger action. The options are **Snapshot** and **Video**.

Network Storage - Cont.

Network Storage

Network Storage Handler

Enable :

Trigger Alarm Detection :

Trigger Motion Detection :

Trigger Tampering Detection :

Trigger Object Detection :

Trigger Audio Detection :

Trigger Scheduled :

Recipient Setup

Network Storage Status : not_mounted

Network address :

Share :

Record Type :

Login Certificate

Username :

Password :

Mount And Remove Network Storage

Login Certificate

Username and Password

Specifies the login username and password for the network storage server.

Mount and Remove Network Storage

Mount

Set up a network connection with the network storage server. All the video recordings or snapshots from event triggers will be uploaded to the network storage server. After the setting is complete, the **Network Storage Status** field will display **ok**.

Remove

Delete the previous setting or set up a new one. After the setting is removed, the **Network Storage Status** field will display **not_mounted**.

Save

Save button to apply the configurations, click on this button once all the settings are confirmed for the new changes to take effect.

Event - Relay Handler

Relay Handler

Configurations

Mode :

Trigger Alarm Detection :

Trigger Motion Detection :

Trigger Tampering Detection :

Trigger Object Detection :

Trigger Audio Detection :

External IR LED :

Type :

Off Time : (0~30s)

Relay Handler Configurations

This section configures the event trigger options for devices connected to the DI/DO of the camera.

Modes

The available options are **Monostable**, or **Bistable**.

Trigger Alarm Detection: When a signal is detected from Alarm in, the Alarm out will be triggered.

Trigger Motion Detection: When a motion detection event is detected, the Alarm out will be triggered.

Trigger Tampering Detection: When a tampering alarm event is detected, the Alarm out will be triggered.

Trigger Object Detection: When an object detection event is detected, the Alarm out will be triggered.

Trigger Audio Detection: When an audio detection event is detected, the Alarm out will be triggered.

Types

The options are **N.O.** and **N.C.**

Off Times

Configure the seconds from 0 to 30 seconds.

Event - SD Record Handler

SD Record Handler

Configurations

Enable :

Trigger Alarm Detection :

Trigger Motion Detection :

Trigger Tampering Detection :

Trigger Object Detection :

Trigger Audio Detection :

Trigger Network Loss Detection :

Trigger Scheduled :

SD Information

Available : 0 MBytes Format SD Card

Usage : 0% (0 / 0) MBytes

Status : not_mounted

Overwrite :

Record Type : Video ▼

SD Record Handler Configurations

Configures which type of event trigger to enable the SD recording and scheduling function. The following options are available:

- Enable Trigger Alarm Detection
- Enable Trigger Motion Detection
- Enable Trigger Tampering Detection
- Enable Trigger Object Detection
- Enable Trigger Audio Detection
- Enable Trigger Network Loss Detection
- Enable Trigger Scheduled

Available

If an SD card is installed, this section will display information on the availability of the SD card.

Usage

If an SD card is installed, this section will display the percentage of the total storage used.

Format SD Card

Formats the SD card, all data stored on the SD card will be erased if this option is used.

Status

Displays whether an SD card is installed or not. If an SD card is detected, ok will be displayed; if an SD card is not detected (or a faulty SD card is used), not_mounted will be displayed.

SD Record Handler Cont.

The screenshot shows the 'SD Record Handler' configuration page. It is divided into two main sections: 'Configurations' and 'SD Information'.
Configurations: This section contains seven settings, each with a radio button or a toggle switch:

- Enable :** A grey toggle switch is currently turned off.
- Trigger Alarm Detection :** An unselected radio button.
- Trigger Motion Detection :** An unselected radio button.
- Trigger Tampering Detection :** An unselected radio button.
- Trigger Object Detection :** An unselected radio button.
- Trigger Audio Detection :** An unselected radio button.
- Trigger Network Loss Detection :** An unselected radio button.
- Trigger Scheduled :** An unselected radio button.

SD Information: This section displays the current state of the SD card and provides controls:

- Available :** 0 MBytes. To the right is a button labeled 'Format SD Card'.
- Usage :** 0% (0 / 0) MBytes.
- Status :** not_mounted.
- Overwrite :** A blue toggle switch is currently turned on.
- Record Type :** A dropdown menu is set to 'Video'.

Overwrite

Enables or disables SD card overwrite.

Record Type

Configures the recording method to record the stream on to the SD card. The options are Video or Snapshot.

Event - TCP Notify

TCP Notify

Configurations

Trigger Alarm Detection :

- IP Address :

- Port : (1025~65535)

- Message :

Trigger Motion Detection :

- IP Address :

- Port : (1025~65535)

- Message :

Trigger Zone1 Motion Detection :

- IP Address :

- Port : (1025~65535)

- Message :

Trigger Zone2 Motion Detection :

- IP Address :

- Port : (1025~65535)

- Message :

TCP Notify Configurations

Trigger Alarm Detection: When a signal is detected from **Alarm in**, the **Alarm out** will be triggered.

Trigger Motion Detection: When a motion detection event is detected, the **Alarm out** will be triggered.

Trigger Motion Zone(1-5) Detection: When a motion event detection in a specified zone is detected, the **Alarm out** will be triggered.

TCP Notify Cont.

Trigger Zone3 Motion Detection :

- IP Address :

- Port : (1025~65535)

- Message :

Trigger Zone4 Motion Detection :

- IP Address :

- Port : (1025~65535)

- Message :

Trigger Zone5 Motion Detection :

- IP Address :

- Port : (1025~65535)

- Message :

Trigger Tampering Detection :

- IP Address :

- Port : (1025~65535)

- Message :

Trigger Object Detection :

- IP Address :

- Port : (1025~65535)

- Message :

Trigger Audio Detection :

- IP Address :

- Port :

- Message :

Trigger Tampering Detection: When a tampering is detected from Alarm in, the Alarm out will be triggered.

Trigger Object Detection: When an object detection event is detected, the Alarm out will be triggered.

Trigger AudioZone(1-5) Detection: When an audio detection is detected, the Alarm out will be triggered.

Video Analytics - Object Detection

Object Detection

Configurations

Enable : Object Schedule

Detect mode :

Detect mode :

Count : Right:0 Left:0

Object Detection

Configurations

Enable : Object Schedule

Detect mode :

Detect mode :

Object Detection

Configurations

Enable : Object Schedule

Detect mode :

Detect zone :

Count : In:0 Out:0

Configurations

Enable:

Enables or disables video analytics. Configures the methods of video analytics, the options are **Object-Counting**, **Line Crossing**, **Zone Object-Counting**, **Zone Intrusion**, **Loitering**, and **Object Left/Removed**.

Object-Counting: Counts objects. Detect mode options that available are One way or Two way.

Line Crossing: Detects objects that cross a virtual line. Detect mode options that available are One way, or Two way.

Zone Object-Counting: Counts objects that move into a user specified area. Detect mode options that available are Inside or Outside.

Object Detection Cont.

Object Detection

Configurations

Enable :

Detect mode : Zone intrusion

Detect zone : Inside

Count Reset

Object Schedule

Object Detection

*Left click and drag to set a specified area.

*Right click and drag to erase a specified area.

Configurations

Enable :

Detect mode : Loitering

Sensitivity : (0~100)

Display Bounding Boxes :

Minimum Loitering Time(Sec) : (1~100)

Object Schedule

Object Detection

*Left click and drag to set a specified area.

*Right click and drag to erase a specified area.

Configurations

Enable :

Detect mode : wrong_way

Sensitivity : (0~100)

Display Bounding Boxes :

Minimum Loitering Time(Sec) : (1~100)

Object Schedule

Zone Intrusion: Detects objects that move into a user specified area. Detect mode options that available are Inside or Outside.

Loitering: Detects objects that remain in a user-specified area beyond a specified time.

Left click and drag to set a specified area. Right click and drag to erase a specified area. The range of sensitivity is 0~100.

Loitering time is the amount of time an object must be in the area to trigger the event. The minimum loitering time range is 1~100(sec).

Wrong way: Continuously monitors a specified area to detect objects that is going on the wrong way. The range of sensitivity is 0~100.

Object Detection Cont.

The image shows two identical configuration panels for object detection. Each panel has a title 'Object Detection', two instructional lines, a 'Configurations' section, and an 'Object Schedule' button.

Object Detection
*Left click and drag to set a specified area.
*Right click and drag to erase a specified area.

Configurations

Enable : Object Schedule

Detect mode :

Sensitivity : (0~100)

Display Bounding Boxes :

Minimum Loitering Time(Sec) : (1~100)

Object Detection
*Left click and drag to set a specified area.
*Right click and drag to erase a specified area.

Configurations

Enable : Object Schedule

Detect mode :

Sensitivity : (0~100)

Display Bounding Boxes :

Minimum Loitering Time(Sec) : (1~100)

Object Left: Continuously monitors a specified area to detect objects that have been left. The range of sensitivity is 0~100.

Object Removed: Continuously monitors a specified area to detect objects that have been removed. The range of sensitivity is 0~100.

Object Detection Cont.

Object Schedule Settings

	0	1	2	3	4	5	6	7	8	9	10	11	12	13	14	15	16	17	18	19	20	21	22	23		
Sun																									S	D
Mon																									S	D
Tue																									S	D
Wed																									S	D
Thu																									S	D
Fri																									S	D
Sat																									S	D

Sunday :	Start :	<input type="text" value="0"/> : <input type="text" value="0"/>	End :	<input type="text" value="23"/> : <input type="text" value="59"/>
Monday :	Start :	<input type="text" value="0"/> : <input type="text" value="0"/>	End :	<input type="text" value="23"/> : <input type="text" value="59"/>
Tuesday :	Start :	<input type="text" value="0"/> : <input type="text" value="0"/>	End :	<input type="text" value="23"/> : <input type="text" value="59"/>
Wednesday :	Start :	<input type="text" value="0"/> : <input type="text" value="0"/>	End :	<input type="text" value="23"/> : <input type="text" value="59"/>
Thursday :	Start :	<input type="text" value="0"/> : <input type="text" value="0"/>	End :	<input type="text" value="23"/> : <input type="text" value="59"/>
Friday :	Start :	<input type="text" value="0"/> : <input type="text" value="0"/>	End :	<input type="text" value="23"/> : <input type="text" value="59"/>
Saturday :	Start :	<input type="text" value="0"/> : <input type="text" value="0"/>	End :	<input type="text" value="23"/> : <input type="text" value="59"/>

Save

Close

Object Schedule Settings

S

Press **S** for a particular weekday to set up a 24-hour schedule automatically.

D

Press **D** for a particular weekday to clear all the previous scheduled settings automatically.

Configure the scheduled time by holding down the mouse button and clicking the time block to enable the schedule settings on the selected time. A light blue color on the time block indicates that the alarm schedule is enabled, while a light grey color indicates that the alarm schedule is disabled.

Alternatively, you can manually enter numbers to configure the hours and minutes from start to end for all weekdays.

Save

Save button to apply the configurations, click on this button once all the settings are confirmed for the new changes to take effect.

Close

Press to leave this schedule setting page.

Object Detection Cont.

Setup Detection Area

Minimum Width :

Minimum Height :

Maximum Width :

Maximum Height :

Sensitivity : (0~255)

Background Weight : (1~255)

Object Type :

Push HTTP Message

Enable :

Host Address :

Push Type :

Accumulation :

Setup Detection Area Settings

Minimum Width

Configures the minimum width of the detection area. Adjust the bar to increase or decrease the minimum width of the detection area.

Minimum Height

Configures the minimum height of the detection area. Adjust the bar to increase or decrease the minimum height of the detection area.

Maximum Width

Configures the maximum width of the detection area. Adjust the bar to increase or decrease the maximum width of the detection area.

Maximum Height

Configures the maximum height of the detection area. Adjust the bar to increase or decrease the maximum height of the detection area.

Sensitivity

Configures the sensitivity of the detection area with the value of 0~255.

Background Weight

Configures the background weight of the detection area with the value of 1~255

Object Type

Configures the object type of the detection area. Object type options are All Objects, Person, and Vehicle.

Object Detection Cont.

The screenshot shows a configuration panel with two main sections: "Setup Detection Area" and "Push HTTP Message".

Setup Detection Area

- Minimum Width :
- Minimum Height :
- Maximum Width :
- Maximum Height :
- Sensitivity : (0~255)
- Background Weight : (1~255)
- Object Type :

Push HTTP Message

- Enable :
- Host Address :
- Push Type :
- Accumulation :

Push HTTP Message Settings

Enable

Enables or disables Push HTTP Message to this camera.

Host Address

To manually input the host address.

Push Type

Configures the push type of Push HTTP Message to this camera. Push Type options are Event, and Period.

Accumulation

Enables or disables the accumulation of Push HTTP Message to this camera.

Mounting Plate Drawing

